

Report No.: 244410724a 001 Page 1 of 69

Client: ESTUN AUTOMATION CO., LTD

Contact Information: 16, Shuige Road, Jiangning Development Zone, Nanjing

Identification/ Controller Device for Servo Motors (Servo Drive)

Model No(s): ED3L 400V

ED3L-xD##-*

(x=10, 15, 20, 30, 50, 75;

stands for A-Z to indicate encoder software edition;

-* stands for null to indicate general manufacture;

-* stands for -0 to -9 or -A to -Z or any other form to indicate client number)

Condition at delivery: Test item complete and undamaged.

Sample Receiving date: 2021-05-26, 2021-08-17, 2021-08-24, 2021-08-25, 2021-08-30, 2021-09-09, 2021-11-08

Testing Period: 2021-05-26 to 2021-11-09

Place of testing: Chemical laboratory Shanghai

Test Specification:

Customer's requirement:

1. Screening Test by XRF Spectroscopy
Cadmium, Lead, Chromium (VI), Mercury, Polybrominated biphenyls (PBB) and Polybrominated diphenyl ethers (PBDE)
BBP, DBP, DEHP, DIBP content
According to RoHS (recast): Restriction of the Use of Certain Hazardous Substances in Electrical and Electronic Equipment, 2011/65/EU Annex II and its amendment.

Test result:

PASS

Other information:

Remark: All data refer to 244329188a 001.

For and on behalf of
TÜV Rheinland (Shanghai) Co., Ltd.



2022-06-10

Ryan Chen / Assistant Manager

Date

Name/Position

Sample information is provided by customer. Test result is drawn according to the kind and extent of tests performed.

This test report relates to the above mentioned test sample. Without permission of the test center this test report is not permitted to be duplicated in extracts. This test report does not entitle to carry any safety mark on this or similar products.

"Decision Rule" document announced in our website (<https://www.tuv.com/landingpage/en/qm-gcn/>) describes the statement of conformity and its rule of enforcement for test results are applicable throughout this test report.

Test Report No.: 244410724a 001

Page 2 of 69

Material List:

Item: Controller Device for Servo Motors (Servo Drive)

ED3L 400V

ED3L-xD##-*

(x=10, 15, 20, 30, 50, 75;

stands for A-Z to indicate encoder software edition;

-* stands for null to indicate general manufacture;

-* stands for -0 to -9 or -A to -Z or any other form to indicate client number)

Material No.	Material	Color	Location
M001	Plastic + printing	grey + beige	refer to photo
M002	Plastic	grey	refer to photo
M003	Plastic + adhesive	silver/black	refer to photo
M004	Metal	silver	refer to photo
M005	Glue	white	refer to photo
M006	Plastic	grey	refer to photo
M007	Plastic	white	refer to photo
M008	Plastic	black	refer to photo
M009	Plastic	red	refer to photo
M010	Plastic	black	refer to photo
M011	Plastic	black	refer to photo
M012	Plastic + adhesive	silver/black/green	refer to photo
M013	Plastic	black	refer to photo
M014	Metal	silver	refer to photo
M015	Plastic	white	refer to photo
M016	Metal	silver	refer to photo
M017	Solder	silver	refer to photo
M018	Plastic	translucent	refer to photo
M019	Metal	silver	refer to photo
M020	PCB board	green	refer to photo
M021	Plastic	black	refer to photo
M022	Metal	silver	refer to photo
M023	Magnet	black	refer to photo
M024	Metal	silver	refer to photo

Test Report No.: 244410724a 001

Page 3 of 69

M025	Metal	copper	refer to photo
M026	Metal	silver	refer to photo
M027	Paper + plastic	brown	refer to photo
M028	Ceramic	white	refer to photo
M029	Plastic + Textile	white	refer to photo
M030	Metal	silver	refer to photo
M031	Metal	silver	refer to photo
M032	Plastic	black	refer to photo
M033	Plastic	black	refer to photo
M034	Metal	silver	refer to photo
M035	Plastic	black	refer to photo
M036	Plastic	grey	refer to photo
M037	Metal	silver	refer to photo
M038	Metal	golden	refer to photo
M039	Plastic	grey	refer to photo
M040	Plastic	black	refer to photo
M041	Plastic	white	refer to photo
M042	Plastic	transparent	refer to photo
M043	Plastic + printing	black + white	refer to photo
M044	Metal	silver	refer to photo
M045	Metal	silver	refer to photo
M046	Metal	silver	refer to photo
M047	Metal	silver	refer to photo
M048	Metal	silver	refer to photo
M049	Metal	silver	refer to photo
M050	Metal	silver	refer to photo
M051	Metal	silver	refer to photo
M052	Metal	silver	refer to photo
M053	Metal	silver	refer to photo
M054	PCB board	green	refer to photo
M055	Metal	golden	refer to photo
M056	Plastic	black	refer to photo

Test Report No.: 244410724a 001

Page 4 of 69

M057	Plastic	black	refer to photo
M058	Plastic	black	refer to photo
M059	Plastic	black	refer to photo
M060	Plastic	black	refer to photo
M061	Plastic	black	refer to photo
M062	Ceramic	brown	refer to photo
M063	Glass	red/black	refer to photo
M064	Ceramic	black	refer to photo
M065	Metal	silver	refer to photo
M066	Ceramic	black/white	refer to photo
M067	Metal	silver	refer to photo
M068	Metal	silver	refer to photo
M069	Plastic	black	refer to photo
M070	Metal	silver	refer to photo
M071	Plastic	black	refer to photo
M072	Metal	silver	refer to photo
M073	Metal	silver	refer to photo
M074	Plastic	black	refer to photo
M075	Metal	silver	refer to photo
M076	Plastic	black	refer to photo
M077	Plastic	white/black/red	refer to photo
M078	PCB board	green	refer to photo
M079	Solder	silver	refer to photo
M080	Plastic	black	refer to photo
M081	Metal	golden	refer to photo
M082	Metal	golden	refer to photo
M083	Plastic	black	refer to photo
M084	Plastic	yellow	refer to photo
M085	Plastic	green	refer to photo
M086	Plastic	black	refer to photo
M087	Metal	golden	refer to photo
M088	Solder	silver	refer to photo

Test Report No.: 244410724a 001

Page 5 of 69

M089	Paper + adhesive	white/black	refer to photo
M090	Plastic	black	refer to photo
M091	Plastic	grey	refer to photo
M092	Metal	golden	refer to photo
M093	Metal	silver	refer to photo
M094	Metal	silver	refer to photo
M095	Metal	silver	refer to photo
M096	Ceramic	white	refer to photo
M097	PCB board	green	refer to photo
M098	Plastic	grey	refer to photo
M099	Ceramic	white	refer to photo
M100	Plastic	black	refer to photo
M101	Plastic	grey	refer to photo
M102	Plastic	black	refer to photo
M103	Ceramic	white	refer to photo
M104	Plastic	black	refer to photo
M105	Plastic	beige/black	refer to photo
M106	Metal	silver	refer to photo
M107	Plastic	white	refer to photo
M108	Metal	golden	refer to photo
M109	Plastic	black	refer to photo
M110	Ceramic	black	refer to photo
M111	Ceramic	yellow	refer to photo
M112	Metal	copper	refer to photo
M113	Magnet	brown	refer to photo
M114	Plastic	black	refer to photo
M115	Plastic	black/white	refer to photo
M116	Plastic	black	refer to photo
M117	Metal	silver	refer to photo
M118	Metal	silver/black	refer to photo
M119	Plastic	black	refer to photo
M120	Metal	copper	refer to photo

Test Report No.: 244410724a 001

Page 6 of 69

M121	Plastic	black	refer to photo
M122	Metal	copper	refer to photo
M123	Plastic	transparent	refer to photo
M124	Plastic + adhesive	yellow/black	refer to photo
M125	Magnet	black	refer to photo
M126	Plastic	black	refer to photo
M127	Plastic	black	refer to photo
M128	Metal	silver	refer to photo
M129	Plastic	blue/white	refer to photo
M130	Metal	silver	refer to photo
M131	Plastic	black	refer to photo
M132	Metal	silver	refer to photo
M133	Plastic	black	refer to photo
M134	Metal	silver	refer to photo
M135	Metal	silver	refer to photo
M136	Plastic	black/golden	refer to photo
M137	Plastic	grey	refer to photo
M138	Solder	silver	refer to photo
M139	Metal	golden	refer to photo
M140	Plastic + printing	grey + golden	refer to photo
M141	Plastic + adhesive	silver/black	refer to photo
M142	Glue	white	refer to photo
M143	Metal	silver	refer to photo
M144	Plastic + printing	black + white	refer to photo
M145	Plastic	white	refer to photo
M146	Plastic	black	refer to photo
M147	Metal	silver	refer to photo
M148	Metal	silver	refer to photo
M149	Metal	silver	refer to photo
M150	Metal	silver	refer to photo
M151	Metal	silver	refer to photo
M152	Metal	silver	refer to photo

Test Report No.: 244410724a 001

Page 7 of 69

M153	Metal	silver	refer to photo
M154	Plastic	white	refer to photo
M155	Metal	silver	refer to photo
M156	Plastic	black	refer to photo
M157	Metal	silver	refer to photo
M158	Plastic	black	refer to photo
M159	Metal	silver	refer to photo
M160	PCB board	green	refer to photo
M161	Plastic	black	refer to photo
M162	Metal	silver	refer to photo
M163	Ceramic	black/white	refer to photo
M164	Metal	silver	refer to photo
M165	Metal	golden	refer to photo
M166	Plastic	black	refer to photo
M167	Metal	silver	refer to photo
M168	Plastic	blue/white	refer to photo
M169	Ceramic	beige	refer to photo
M170	Plastic	black	refer to photo
M171	Plastic	black	refer to photo
M172	Plastic	white/black	refer to photo
M173	Paper + adhesive	white/black	refer to photo
M174	Plastic	black	refer to photo
M175	Plastic	grey	refer to photo
M176	Plastic	black/white	refer to photo
M177	Plastic	black	refer to photo
M178	Plastic	black	refer to photo
M179	Ceramic	black	refer to photo
M180	Ceramic	yellow	refer to photo
M181	Plastic	grey	refer to photo
M182	Plastic	black	refer to photo
M183	Metal	golden	refer to photo
M184	Metal	golden	refer to photo

Test Report No.: 244410724a 001

Page 8 of 69

M185	Plastic	black	refer to photo
M186	Metal	silver	refer to photo
M187	Metal	silver	refer to photo
M188	Plastic	black	refer to photo
M189	Metal	golden	refer to photo
M190	Plastic	black	refer to photo
M191	Metal	silver	refer to photo
M192	Plastic	green	refer to photo
M193	Plastic	yellow	refer to photo
M194	Metal	silver	refer to photo
M195	Plastic	black	refer to photo
M196	Metal	golden	refer to photo
M197	Plastic	multicolor	refer to photo
M198	Plastic	black	refer to photo
M199	Metal	silver	refer to photo
M200	Plastic	black	refer to photo
M201	Metal	silver	refer to photo
M202	Plastic	black	refer to photo
M203	Metal	golden	refer to photo
M204	Metal	silver	refer to photo
M205	PCB board	green	refer to photo
M206	Solder	silver	refer to photo
M207	Glass	multicolor	refer to photo
M208	Plastic	black	refer to photo
M209	Plastic	white	refer to photo
M210	Metal	silver	refer to photo
M211	Magnet	black	refer to photo
M212	Plastic	black	refer to photo
M213	Metal	copper	refer to photo
M214	Plastic + adhesive	yellow	refer to photo
M215	Solder	silver	refer to photo
M216	Plastic + printing	grey + beige	refer to photo

Test Report No.: 244410724a 001

Page 9 of 69

M217	Plastic	transparent	refer to photo
M218	Plastic + adhesive	silver/black	refer to photo
M219	Metal	silver	refer to photo
M220	Plastic	grey	refer to photo
M221	Plastic	white	refer to photo
M222	Metal	silver	refer to photo
M223	Plastic	white	refer to photo
M224	Plastic + Textile	white	refer to photo
M225	Metal	silver	refer to photo
M226	Metal	silver	refer to photo
M227	Metal	silver	refer to photo
M228	Metal	silver	refer to photo
M229	Metal	silver	refer to photo
M230	Metal	silver	refer to photo
M231	Metal	silver	refer to photo
M232	Metal	silver	refer to photo
M233	Metal	silver	refer to photo
M234	Metal	silver	refer to photo
M235	Metal	silver	refer to photo
M236	Metal	silver	refer to photo
M237	Metal	silver	refer to photo
M238	Metal	silver	refer to photo
M239	Metal	silver	refer to photo
M240	Metal	silver	refer to photo
M241	Metal	silver	refer to photo
M242	Metal	silver	refer to photo
M243	Metal	silver	refer to photo
M244	Metal	silver	refer to photo
M245	Plastic	white	refer to photo
M246	Metal	silver	refer to photo
M247	Plastic	black	refer to photo
M248	Plastic	black	refer to photo

Test Report No.: 244410724a 001

Page 10 of 69

M249	Glue	black	refer to photo
M250	Metal	silver	refer to photo
M251	Plastic + coating	black + white	refer to photo
M252	Plastic	white	refer to photo
M253	Plastic	black	refer to photo
M254	Plastic	grey	refer to photo
M255	Metal	silver	refer to photo
M256	Metal	silver	refer to photo
M257	Plastic	black	refer to photo
M258	Plastic + adhesive	multicolor	refer to photo
M259	Metal	silver	refer to photo
M260	Magnet	black	refer to photo
M261	Metal	silver	refer to photo
M262	Plastic	black	refer to photo
M263	Metal	silver	refer to photo
M264	Metal	silver	refer to photo
M265	Metal	copper	refer to photo
M266	Plastic	black	refer to photo
M267	Metal	silver	refer to photo
M268	Plastic	black	refer to photo
M269	Plastic	red	refer to photo
M270	Plastic	black	refer to photo
M271	PCB board	blue	refer to photo
M272	Plastic	black	refer to photo
M273	Plastic	black	refer to photo
M274	Glue	yellow	refer to photo
M275	Ceramic	black/white	refer to photo
M276	Ceramic	beige	refer to photo
M277	Metal	silver	refer to photo
M278	Metal	copper	refer to photo
M279	Solder	silver	refer to photo
M280	Plastic	black/white	refer to photo

Test Report No.: 244410724a 001

Page 11 of 69

M281	Plastic	black	refer to photo
M282	Metal	silver	refer to photo
M283	Ceramic	yellow	refer to photo
M284	Metal	silver	refer to photo
M285	Metal	silver	refer to photo
M286	Plastic	white	refer to photo
M287	Glue	white	refer to photo
M288	Ceramic	white	refer to photo
M289	Plastic	black	refer to photo
M290	Plastic	black	refer to photo
M291	Metal	silver	refer to photo
M292	Plastic	black	refer to photo
M293	Metal	golden	refer to photo
M294	Plastic	black	refer to photo
M295	Plastic	grey	refer to photo
M296	Plastic	black	refer to photo
M297	Metal	copper	refer to photo
M298	Magnet	red	refer to photo
M299	Ceramic	black	refer to photo
M300	Plastic	red	refer to photo
M301	Plastic	grey	refer to photo
M302	Plastic	black	refer to photo
M303	Metal	golden	refer to photo
M304	Metal	silver	refer to photo
M305	Plastic	black	refer to photo
M306	Metal	silver	refer to photo
M307	Plastic	blue/white	refer to photo
M308	Plastic + adhesive	yellow/black	refer to photo
M309	Magnet	black	refer to photo
M310	Plastic	black	refer to photo
M311	Metal	copper	refer to photo
M312	Metal	copper	refer to photo

Test Report No.: 244410724a 001

Page 12 of 69

M313	Plastic	translucent	refer to photo
M314	Plastic	white	refer to photo
M315	Metal	silver	refer to photo
M316	Plastic	black	refer to photo
M317	Plastic	white/black	refer to photo
M318	Metal	silver/black	refer to photo
M319	Metal	copper	refer to photo
M320	Metal	silver	refer to photo
M321	Plastic	black	refer to photo
M322	Metal	silver	refer to photo
M323	Plastic	black	refer to photo
M324	Plastic	grey	refer to photo
M325	Metal	silver	refer to photo
M326	Plastic	grey	refer to photo
M327	PCB board	green	refer to photo
M328	Solder	silver	refer to photo
M329	Ceramic	black/white	refer to photo
M330	Ceramic	beige	refer to photo
M331	Plastic	black	refer to photo
M332	Plastic	black	refer to photo
M333	Plastic	black	refer to photo
M334	Plastic	black	refer to photo
M335	Plastic	black	refer to photo
M336	Plastic	black	refer to photo
M337	Glass	multicolor	refer to photo
M338	Metal	silver	refer to photo
M339	Metal	silver	refer to photo
M340	Plastic	black	refer to photo
M341	Metal	silver	refer to photo
M342	Plastic	black	refer to photo
M343	Metal	golden	refer to photo
M344	Plastic	black	refer to photo

Test Report No.: 244410724a 001

Page 13 of 69

M345	Metal	golden	refer to photo
M346	Metal	silver	refer to photo
M347	Plastic	yellow	refer to photo
M348	Metal	golden	refer to photo
M349	Plastic	black	refer to photo
M350	Plastic	green	refer to photo
M351	Metal	silver	refer to photo
M352	Plastic	black	refer to photo
M353	Metal	silver	refer to photo
M354	Metal	silver	refer to photo
M355	Plastic	black	refer to photo
M356	Plastic	black	refer to photo
M357	Plastic	multicolor	refer to photo
M358	PCB board	green	refer to photo
M359	Solder	silver	refer to photo
M360	PCB board	green	refer to photo
M361	Paper + adhesive	white/black	refer to photo
M362	Solder	black/white	refer to photo
M363	Ceramic	silver	refer to photo
M364	Plastic + printing	grey + beige	refer to photo
M365	Plastic + adhesive	silver/black	refer to photo
M366	Plastic + printing	black + white	refer to photo
M367	Plastic	transparent	refer to photo
M368	Metal	silver	refer to photo
M369	Glue	white	refer to photo
M370	Plastic	white	refer to photo
M371	Plastic	black	refer to photo
M372	Metal	silver	refer to photo
M373	Metal	silver	refer to photo
M374	Metal	silver	refer to photo
M375	Metal	silver	refer to photo
M376	Metal	silver	refer to photo

Test Report No.: 244410724a 001

Page 14 of 69

M377	Metal	silver	refer to photo
M378	Metal	silver	refer to photo
M379	Metal	silver	refer to photo
M380	Metal	silver	refer to photo
M381	Metal	silver	refer to photo
M382	Metal	silver	refer to photo
M383	Metal	silver	refer to photo
M384	Metal	silver	refer to photo
M385	Metal	silver	refer to photo
M386	Plastic	black	refer to photo
M387	Metal	silver	refer to photo
M388	Plastic	white	refer to photo
M389	Metal	silver	refer to photo
M390	Plastic	black	refer to photo
M391	Glue	black	refer to photo
M392	Metal	silver	refer to photo
M393	Plastic	blue/whtie	refer to photo
M394	Metal	silver	refer to photo
M395	Glass	multicolor	refer to photo
M396	Plastic	black	refer to photo
M397	Plastic	black	refer to photo
M398	Plastic + adhesive	yellow	refer to photo
M399	Metal	copper	refer to photo
M400	Plastic	black	refer to photo
M401	Ceramic	beige	refer to photo
M402	Ceramic	black/white	refer to photo
M403	Metal	copper	refer to photo
M404	Plastic	black	refer to photo
M405	Metal	silver	refer to photo
M406	Plastic	black	refer to photo
M407	Plastic	white	refer to photo
M408	Plastic	black	refer to photo

Test Report No.: 244410724a 001

Page 15 of 69

M409	Paper + adhesive	white/black	refer to photo
M410	Plastic	grey	refer to photo
M411	Plastic	black/white	refer to photo
M412	Plastic	black	refer to photo
M413	Plastic	black	refer to photo
M414	Ceramic	black	refer to photo
M415	Ceramic	yellow	refer to photo
M416	Plastic	grey	refer to photo
M417	Plastic	white	refer to photo
M418	Metal	silver	refer to photo
M419	Plastic	black	refer to photo
M420	Plastic	black	refer to photo
M421	Metal	silver	refer to photo
M422	Metal	silver	refer to photo
M423	Metal	silver	refer to photo
M424	Plastic	black	refer to photo
M425	Plastic	black	refer to photo
M426	Metal	golden	refer to photo
M427	Plastic	black	refer to photo
M428	Metal	golden	refer to photo
M429	Plastic	black	refer to photo
M430	Metal	golden	refer to photo
M431	Metal	silver	refer to photo
M432	Plastic	black	refer to photo
M433	Metal	golden	refer to photo
M434	Metal	silver	refer to photo
M435	Plastic	black	refer to photo
M436	Plastic	black	refer to photo
M437	Plastic	multicolor	refer to photo
M438	PCB board	green	refer to photo
M439	Solder	silver	refer to photo
M440	Plastic	black	refer to photo

Test Report No.: 244410724a 001

Page 16 of 69

M441	Metal	golden	refer to photo
M442	PCB board	green	refer to photo
M443	Solder	silver	refer to photo
M444	Plastic + adhesive	silver/black	refer to photo
M445	Plastic + printing	grey + beige	refer to photo
M446	Plastic	transparent	refer to photo
M447	Plastic + printing	black + white	refer to photo
M448	Metal	silver	refer to photo
M449	Plastic	grey	refer to photo
M450	Plastic	white	refer to photo
M451	Metal	silver	refer to photo
M452	Metal	silver	refer to photo
M453	Metal	silver	refer to photo
M454	Metal	silver	refer to photo
M455	Metal	silver	refer to photo
M456	Metal	silver	refer to photo
M457	Metal	silver	refer to photo
M458	Metal	silver	refer to photo
M459	Metal	silver	refer to photo
M460	Metal	silver	refer to photo
M461	Metal	silver	refer to photo
M462	Metal	silver	refer to photo
M463	Plastic	white	refer to photo
M464	Plastic	black	refer to photo
M465	Plastic	grey	refer to photo
M466	Metal	silver	refer to photo
M467	Metal	silver	refer to photo
M468	Plastic	black	refer to photo
M469	Plastic	grey/red	refer to photo
M470	Metal	silver	refer to photo
M471	Metal	silver	refer to photo
M472	Ceramic	white	refer to photo

Test Report No.: 244410724a 001

Page 17 of 69

M473	Metal	silver	refer to photo
M474	Plastic + Textile	white	refer to photo
M475	Paper + plastic	brown	refer to photo
M476	Metal	silver	refer to photo
M477	Plastic	white	refer to photo
M478	Metal	silver	refer to photo
M479	Plastic	black	refer to photo
M480	Plastic	black	refer to photo
M481	Glue	black	refer to photo
M482	Metal	silver	refer to photo
M483	Plastic + adhesive	multicolor	refer to photo
M484	Plastic	black	refer to photo
M485	Magnet	black	refer to photo
M486	Metal	silver	refer to photo
M487	Metal	silver	refer to photo
M488	Metal	copper	refer to photo
M489	Plastic	black	refer to photo
M490	Plastic	black	refer to photo
M491	Plastic	black	refer to photo
M492	Plastic	red	refer to photo
M493	Metal	silver	refer to photo
M494	Solder	silver	refer to photo
M495	PCB board	green	refer to photo
M496	Plastic	black	refer to photo
M497	Metal	silver	refer to photo
M498	Plastic	black	refer to photo
M499	Metal	silver	refer to photo
M500	Metal	silver	refer to photo
M501	Metal	silver	refer to photo
M502	Plastic	black	refer to photo
M503	Metal	silver	refer to photo
M504	Ceramic	yellow	refer to photo

Test Report No.: 244410724a 001

Page 18 of 69

M505	Glue	white	refer to photo
M506	Metal	silver	refer to photo
M507	Paper + adhesive	white/black	refer to photo
M508	Plastic	black/white	refer to photo
M509	Plastic	black	refer to photo
M510	Metal	copper	refer to photo
M511	Plastic	black	refer to photo
M512	Plastic	grey	refer to photo
M513	Plastic	blue/white	refer to photo
M514	Metal	silver	refer to photo
M515	Plastic	white	refer to photo
M516	Metal	silver	refer to photo
M517	Plastic	black	refer to photo
M518	Plastic	white	refer to photo
M519	Plastic + adhesive	yellow/white	refer to photo
M520	Plastic	black	refer to photo
M521	Metal	golden	refer to photo
M522	Plastic	transparent	refer to photo
M523	Metal	golden	refer to photo
M524	Metal	silver/black	refer to photo
M525	Plastic	grey	refer to photo
M526	Plastic	black	refer to photo
M527	Ceramic	white	refer to photo
M528	Ceramic	white	refer to photo
M529	Metal	silver	refer to photo
M530	Metal	silver	refer to photo
M531	Plastic	black	refer to photo
M532	Metal	golden	refer to photo
M533	Plastic	black	refer to photo
M534	Plastic	grey	refer to photo
M535	Plastic	black	refer to photo
M536	Ceramic	white	refer to photo

Test Report No.: 244410724a 001

Page 19 of 69

M537	Metal	golden	refer to photo
M538	Magnet	red	refer to photo
M539	Plastic	grey	refer to photo
M540	Plastic	grey	refer to photo
M541	Plastic	black	refer to photo
M542	Metal	golden	refer to photo
M543	Plastic	black	refer to photo
M544	Plastic	black	refer to photo
M545	Metal	golden	refer to photo
M546	Plastic	black	refer to photo
M547	Plastic	black	refer to photo
M548	Metal	silver	refer to photo
M549	Plastic	black	refer to photo
M550	Metal	golden	refer to photo
M551	Metal	silver	refer to photo
M552	Metal	silver	refer to photo
M553	Plastic	black	refer to photo
M554	Metal	golden	refer to photo
M555	Metal	silver	refer to photo
M556	Plastic	black	refer to photo
M557	Metal	golden	refer to photo
M558	Plastic	black	refer to photo
M559	Metal	silver	refer to photo
M560	Plastic	black	refer to photo
M561	Plastic	multicolor	refer to photo
M562	PCB board	green	refer to photo
M563	Solder	silver	refer to photo
M564	PCB board	green	refer to photo
M565	Solder	silver	refer to photo
M566	Ceramic	black/white	refer to photo
M567	Ceramic	beige	refer to photo
M568	PCB board	green	refer to photo

Test Report No.: 244410724a 001

Page 20 of 69

M569	Solder	silver	refer to photo
------	--------	--------	----------------

Test Report No.: 244410724a 001

Page 21 of 69

1.Screening Test by XRF spectroscopy

 Test Method: Cadmium, Lead, Mercury, Chromium, Bromine
 -- With reference to IEC 62321-3-1:2013

Test Result:

Material No.	Cd	Cr	Pb	Hg	Br
M001	BL	BL	BL	BL	BL
M002	BL	BL	BL	BL	BL
M003	BL	BL	BL	BL	BL
M004	BL	BL	BL	BL	n.a.
M005	BL	BL	BL	BL	BL
M006	BL	BL	BL	BL	BL
M007	BL	BL	BL	BL	BL
M008	BL	BL	BL	BL	d*1
M009	BL	BL	BL	BL	BL
M010	BL	BL	BL	BL	BL
M011	BL	BL	BL	BL	d*1
M012	BL	BL	BL	BL	BL
M013	BL	BL	BL	BL	BL
M014	BL	BL	BL	BL	n.a.
M015	BL	BL	BL	BL	BL
M016	BL	BL	BL	BL	n.a.
M017	BL	BL	BL	BL	n.a.
M018	BL	BL	BL	BL	BL
M019	BL	d*1	BL	BL	n.a.
M020	BL	BL	BL	BL	d*1
M021	BL	BL	BL	BL	d*1
M022	BL	d*1	BL	BL	n.a.
M023	BL	BL	BL	BL	n.a.
M024	BL	d*1	BL	BL	n.a.
M025	BL	BL	BL	BL	n.a.
M026	BL	BL	BL	BL	n.a.
M027	BL	BL	BL	BL	BL
M028	BL	BL	BL	BL	n.a.
M029	BL	BL	BL	BL	BL
M030	BL	BL	BL	BL	n.a.
M031	BL	d*1	BL	BL	n.a.
M032	BL	BL	BL	BL	BL
M033	BL	BL	BL	BL	BL
M034	BL	BL	BL	BL	n.a.
M035	BL	BL	BL	BL	d*1
M036	BL	BL	BL	BL	BL
M037	BL	d*1	BL	BL	n.a.

Test Report No.: 244410724a 001

Page 22 of 69

M038	BL	BL	BL	BL	n.a.
M039	BL	BL	BL	BL	BL
M040	BL	BL	BL	BL	d*1
M041	BL	BL	BL	BL	BL
M042	BL	BL	BL	BL	BL
M043	BL	BL	BL	BL	BL
M044	BL	BL	BL	BL	n.a.
M045	BL	BL	BL	BL	n.a.
M046	BL	d*1	BL	BL	n.a.
M047	BL	BL	BL	BL	n.a.
M048	BL	d*1	BL	BL	n.a.
M049	BL	d*1	BL	BL	n.a.
M050	BL	d*1	BL	BL	n.a.
M051	BL	d*1	BL	BL	n.a.
M052	BL	d*1	BL	BL	n.a.
M053	BL	d*1	BL	BL	n.a.
M054	BL	BL	BL	BL	d*1
M055	BL	BL	BL	BL	n.a.
M056	BL	BL	BL	BL	d*1
M057	BL	BL	BL	BL	BL
M058	BL	BL	BL	BL	BL
M059	BL	BL	BL	BL	BL
M060	BL	BL	BL	BL	d*1
M061	BL	BL	BL	BL	BL
M062	BL	BL	BL	BL	n.a.
M063	BL	BL	d*1	BL	n.a.
M064	BL	BL	BL	BL	n.a.
M065	BL	BL	BL	BL	n.a.
M066	BL	BL	d*1	BL	n.a.
M067	BL	BL	BL	BL	n.a.
M068	BL	BL	BL	BL	n.a.
M069	BL	BL	BL	BL	d*1
M070	BL	BL	BL	BL	n.a.
M071	BL	BL	BL	BL	BL
M072	BL	BL	BL	BL	n.a.
M073	BL	BL	BL	BL	n.a.
M074	BL	BL	BL	BL	BL
M075	BL	BL	BL	BL	n.a.
M076	BL	BL	BL	BL	BL
M077	BL	BL	BL	BL	d*1
M078	BL	BL	BL	BL	BL
M079	BL	BL	BL	BL	n.a.
M080	BL	BL	BL	BL	d*1

Test Report No.: 244410724a 001

Page 23 of 69

M081	BL	BL	BL	BL	n.a.
M082	BL	BL	BL	BL	n.a.
M083	BL	BL	BL	BL	d*1
M084	BL	BL	BL	BL	BL
M085	BL	BL	BL	BL	BL
M086	BL	BL	BL	BL	d*1
M087	BL	BL	BL	BL	n.a.
M088	BL	BL	BL	BL	n.a.
M089	BL	BL	BL	BL	BL
M090	BL	BL	BL	BL	BL
M091	BL	BL	BL	BL	BL
M092	BL	BL	BL	BL	n.a.
M093	BL	BL	BL	BL	n.a.
M094	BL	BL	BL	BL	n.a.
M095	BL	BL	BL	BL	n.a.
M096	BL	BL	BL	BL	n.a.
M097	BL	BL	BL	BL	d*1
M098	BL	BL	BL	BL	d*2
M099	BL	BL	BL	BL	n.a.
M100	BL	BL	BL	BL	BL
M101	BL	BL	BL	BL	d*2
M102	BL	BL	BL	BL	d*2
M103	BL	BL	BL	BL	n.a.
M104	BL	BL	BL	BL	d*2
M105	BL	BL	BL	BL	d*2
M106	BL	BL	BL	BL	n.a.
M107	BL	BL	BL	BL	BL
M108	BL	BL	BL	BL	n.a.
M109	BL	BL	BL	BL	d*2
M110	BL	BL	BL	BL	n.a.
M111	BL	BL	BL	BL	n.a.
M112	BL	BL	BL	BL	n.a.
M113	BL	BL	BL	BL	n.a.
M114	BL	BL	BL	BL	d*2
M115	BL	BL	BL	BL	BL
M116	BL	BL	BL	BL	BL
M117	BL	BL	BL	BL	n.a.
M118	BL	BL	BL	BL	n.a.
M119	BL	BL	BL	BL	BL
M120	BL	BL	BL	BL	n.a.
M121	BL	BL	BL	BL	BL
M122	BL	BL	BL	BL	n.a.
M123	BL	BL	BL	BL	BL

Test Report No.: 244410724a 001

Page 24 of 69

M124	BL	BL	BL	BL	BL
M125	BL	BL	BL	BL	n.a.
M126	BL	BL	BL	BL	BL
M127	BL	BL	BL	BL	BL
M128	BL	BL	BL	BL	n.a.
M129	BL	BL	BL	BL	BL
M130	BL	BL	BL	BL	n.a.
M131	BL	BL	BL	BL	BL
M132	BL	BL	BL	BL	n.a.
M133	BL	BL	BL	BL	BL
M134	BL	BL	BL	BL	n.a.
M135	BL	BL	BL	BL	n.a.
M136	BL	BL	BL	BL	BL
M137	BL	BL	BL	BL	d*2
M138	BL	BL	BL	BL	n.a.
M139	BL	BL	BL	BL	n.a.
M140	BL	BL	BL	BL	BL
M141	BL	BL	BL	BL	BL
M142	BL	BL	BL	BL	BL
M143	BL	d*1	BL	BL	n.a.
M144	BL	BL	BL	BL	BL
M145	BL	BL	BL	BL	BL
M146	BL	BL	BL	BL	d*2
M147	BL	d*1	BL	BL	n.a.
M148	BL	d*1	BL	BL	n.a.
M149	BL	d*1	BL	BL	n.a.
M150	BL	d*1	BL	BL	n.a.
M151	BL	d*1	BL	BL	n.a.
M152	BL	BL	BL	BL	n.a.
M153	BL	d*1	BL	BL	n.a.
M154	BL	BL	BL	BL	BL
M155	BL	BL	BL	BL	n.a.
M156	BL	BL	BL	BL	BL
M157	BL	d*1	BL	BL	n.a.
M158	BL	BL	BL	BL	BL
M159	BL	BL	BL	BL	n.a.
M160	BL	BL	BL	BL	d*2
M161	BL	BL	BL	BL	d*2
M162	BL	BL	BL	BL	n.a.
M163	BL	BL	BL	BL	n.a.
M164	BL	d*1	BL	BL	n.a.
M165	BL	BL	BL	BL	n.a.
M166	BL	BL	BL	BL	BL

Test Report No.: 244410724a 001

Page 25 of 69

M167	BL	BL	BL	BL	n.a.
M168	BL	BL	BL	BL	BL
M169	BL	BL	BL	BL	n.a.
M170	BL	BL	BL	BL	BL
M171	BL	BL	BL	BL	BL
M172	BL	BL	BL	BL	d*2
M173	BL	BL	BL	BL	BL
M174	BL	BL	BL	BL	BL
M175	BL	BL	BL	BL	d*2
M176	BL	BL	BL	BL	BL
M177	BL	BL	BL	BL	BL
M178	BL	BL	BL	BL	d*2
M179	BL	BL	BL	BL	n.a.
M180	BL	BL	BL	BL	n.a.
M181	BL	BL	BL	BL	d*2
M182	BL	BL	BL	BL	d*1
M183	BL	BL	BL	BL	n.a.
M184	BL	BL	BL	BL	n.a.
M185	BL	BL	BL	BL	d*1
M186	BL	BL	BL	BL	n.a.
M187	BL	BL	BL	BL	n.a.
M188	BL	BL	BL	BL	d*1
M189	BL	BL	BL	BL	n.a.
M190	BL	BL	BL	BL	d*1
M191	BL	BL	BL	BL	n.a.
M192	BL	BL	BL	BL	BL
M193	BL	BL	BL	BL	BL
M194	BL	BL	BL	BL	n.a.
M195	BL	BL	BL	BL	d*1
M196	BL	BL	BL	BL	n.a.
M197	BL	BL	BL	BL	BL
M198	BL	BL	BL	BL	BL
M199	BL	d*1	BL	BL	n.a.
M200	BL	BL	BL	BL	BL
M201	BL	BL	BL	BL	n.a.
M202	BL	BL	BL	BL	BL
M203	BL	BL	BL	BL	n.a.
M204	BL	BL	BL	BL	n.a.
M205	BL	BL	BL	BL	d*1
M206	BL	BL	BL	BL	n.a.
M207	BL	BL	d*1	BL	n.a.
M208	BL	BL	BL	BL	BL
M209	BL	BL	BL	BL	BL

Test Report No.: 244410724a 001

Page 26 of 69

M210	BL	BL	BL	BL	n.a.
M211	BL	BL	BL	BL	n.a.
M212	BL	BL	BL	BL	BL
M213	BL	BL	BL	BL	n.a.
M214	BL	BL	BL	BL	BL
M215	BL	BL	BL	BL	n.a.
M216	BL	BL	BL	BL	BL
M217	BL	BL	BL	BL	BL
M218	BL	BL	BL	BL	BL
M219	BL	BL	BL	BL	n.a.
M220	BL	BL	BL	BL	BL
M221	BL	BL	BL	BL	BL
M222	BL	BL	BL	BL	n.a.
M223	BL	BL	BL	BL	BL
M224	BL	BL	BL	BL	BL
M225	BL	BL	BL	BL	n.a.
M226	BL	d*1	BL	BL	n.a.
M227	BL	d*1	BL	BL	n.a.
M228	BL	d*1	BL	BL	n.a.
M229	BL	d*1	BL	BL	n.a.
M230	BL	d*1	BL	BL	n.a.
M231	BL	d*1	BL	BL	n.a.
M232	BL	d*1	BL	BL	n.a.
M233	BL	d*1	BL	BL	n.a.
M234	BL	d*1	BL	BL	n.a.
M235	BL	d*1	BL	BL	n.a.
M236	BL	d*1	BL	BL	n.a.
M237	BL	d*1	BL	BL	n.a.
M238	BL	d*1	BL	BL	n.a.
M239	BL	d*1	BL	BL	n.a.
M240	BL	d*1	BL	BL	n.a.
M241	BL	d*1	BL	BL	n.a.
M242	BL	d*1	BL	BL	n.a.
M243	BL	d*1	BL	BL	n.a.
M244	BL	BL	BL	BL	n.a.
M245	BL	BL	BL	BL	BL
M246	BL	BL	BL	BL	n.a.
M247	BL	BL	BL	BL	BL
M248	BL	BL	BL	BL	BL
M249	BL	BL	BL	BL	BL
M250	BL	d*1	BL	BL	n.a.
M251	BL	BL	BL	BL	BL
M252	BL	BL	BL	BL	BL

Test Report No.: 244410724a 001

Page 27 of 69

M253	BL	BL	BL	BL	d*1
M254	BL	BL	BL	BL	BL
M255	BL	BL	BL	BL	n.a.
M256	BL	d*1	BL	BL	n.a.
M257	BL	BL	BL	BL	d*1
M258	BL	BL	BL	BL	BL
M259	BL	d*1	BL	BL	n.a.
M260	BL	BL	BL	BL	n.a.
M261	BL	d*1	BL	BL	n.a.
M262	BL	BL	BL	BL	d*1
M263	BL	d*1	BL	BL	n.a.
M264	BL	d*1	BL	BL	n.a.
M265	BL	BL	BL	BL	n.a.
M266	BL	BL	BL	BL	d*1
M267	BL	d*1	BL	BL	n.a.
M268	BL	BL	BL	BL	BL
M269	BL	BL	BL	BL	BL
M270	BL	BL	BL	BL	BL
M271	BL	BL	BL	BL	d*1
M272	BL	BL	BL	BL	BL
M273	BL	BL	BL	BL	BL
M274	BL	BL	BL	BL	BL
M275	BL	d*1	BL	BL	n.a.
M276	BL	BL	BL	BL	n.a.
M277	BL	BL	BL	BL	n.a.
M278	BL	BL	BL	BL	n.a.
M279	BL	BL	BL	BL	n.a.
M280	BL	BL	BL	BL	BL
M281	BL	BL	BL	BL	BL
M282	BL	BL	BL	BL	n.a.
M283	BL	BL	BL	BL	n.a.
M284	BL	BL	BL	BL	n.a.
M285	BL	BL	BL	BL	n.a.
M286	BL	BL	BL	BL	BL
M287	BL	BL	BL	BL	BL
M288	BL	BL	BL	BL	n.a.
M289	BL	BL	BL	BL	d*1
M290	BL	BL	BL	BL	BL
M291	BL	BL	BL	BL	n.a.
M292	BL	BL	BL	BL	d*1
M293	BL	BL	BL	BL	n.a.
M294	BL	BL	BL	BL	d*1
M295	BL	BL	BL	BL	d*1

Test Report No.: 244410724a 001

Page 28 of 69

M296	BL	BL	BL	BL	d*1
M297	BL	BL	BL	BL	n.a.
M298	BL	BL	BL	BL	n.a.
M299	BL	BL	BL	BL	BL
M300	BL	BL	BL	BL	d*1
M301	BL	BL	BL	BL	BL
M302	BL	BL	BL	BL	BL
M303	BL	BL	BL	BL	n.a.
M304	BL	BL	BL	BL	n.a.
M305	BL	BL	BL	BL	d*1
M306	BL	BL	BL	BL	n.a.
M307	BL	BL	BL	BL	BL
M308	BL	BL	BL	BL	BL
M309	BL	BL	BL	BL	n.a.
M310	BL	BL	BL	BL	BL
M311	BL	BL	BL	BL	n.a.
M312	BL	BL	BL	BL	n.a.
M313	BL	BL	BL	BL	BL
M314	BL	BL	BL	BL	BL
M315	BL	BL	BL	BL	n.a.
M316	BL	BL	BL	BL	BL
M317	BL	BL	BL	BL	d*1
M318	BL	BL	BL	BL	n.a.
M319	BL	d*1	BL	BL	n.a.
M320	BL	d*1	BL	BL	n.a.
M321	BL	BL	BL	BL	d*1
M322	BL	BL	BL	BL	n.a.
M323	BL	BL	BL	BL	BL
M324	BL	BL	BL	BL	d*1
M325	BL	BL	BL	BL	n.a.
M326	BL	BL	BL	BL	d*1
M327	BL	BL	BL	BL	BL
M328	BL	BL	BL	BL	n.a.
M329	BL	BL	d*1	BL	n.a.
M330	BL	BL	BL	BL	n.a.
M331	BL	BL	BL	BL	d*1
M332	BL	BL	BL	BL	BL
M333	BL	BL	BL	BL	BL
M334	BL	BL	BL	BL	d*1
M335	BL	BL	BL	BL	BL
M336	BL	BL	BL	BL	BL
M337	d*1	BL	d*1	BL	n.a.
M338	BL	BL	BL	BL	n.a.

Test Report No.: 244410724a 001

Page 29 of 69

M339	BL	BL	BL	BL	n.a.
M340	BL	BL	BL	BL	d*1
M341	BL	BL	BL	BL	n.a.
M342	BL	BL	BL	BL	d*1
M343	BL	BL	BL	BL	n.a.
M344	BL	BL	BL	BL	d*1
M345	BL	BL	BL	BL	n.a.
M346	BL	BL	BL	BL	n.a.
M347	BL	BL	BL	BL	BL
M348	BL	BL	BL	BL	n.a.
M349	BL	BL	BL	BL	d*1
M350	BL	BL	BL	BL	BL
M351	BL	BL	BL	BL	n.a.
M352	BL	BL	BL	BL	BL
M353	BL	BL	BL	BL	n.a.
M354	BL	BL	BL	BL	n.a.
M355	BL	BL	BL	BL	BL
M356	BL	BL	BL	BL	BL
M357	BL	BL	BL	BL	BL
M358	BL	BL	BL	BL	d*1
M359	BL	BL	BL	BL	n.a.
M360	BL	BL	BL	BL	d*1
M361	BL	BL	BL	BL	BL
M362	BL	BL	BL	BL	n.a.
M363	BL	BL	BL	BL	n.a.
M364	BL	BL	BL	BL	BL
M365	BL	BL	BL	BL	BL
M366	BL	BL	BL	BL	BL
M367	BL	BL	BL	BL	BL
M368	BL	BL	BL	BL	n.a.
M369	BL	BL	BL	BL	BL
M370	BL	BL	BL	BL	BL
M371	BL	BL	BL	BL	d*1
M372	BL	d*1	BL	BL	n.a.
M373	BL	BL	BL	BL	n.a.
M374	BL	d*1	BL	BL	n.a.
M375	BL	d*1	BL	BL	n.a.
M376	BL	d*1	BL	BL	n.a.
M377	BL	d*1	BL	BL	n.a.
M378	BL	d*1	BL	BL	n.a.
M379	BL	d*1	BL	BL	n.a.
M380	BL	d*1	BL	BL	n.a.
M381	BL	d*1	BL	BL	n.a.

Test Report No.: 244410724a 001

Page 30 of 69

M382	BL	d*1	BL	BL	n.a.
M383	BL	d*1	BL	BL	n.a.
M384	BL	d*1	BL	BL	n.a.
M385	BL	d*1	BL	BL	n.a.
M386	BL	BL	BL	BL	BL
M387	BL	BL	BL	BL	n.a.
M388	BL	BL	BL	BL	BL
M389	BL	BL	BL	BL	n.a.
M390	BL	BL	BL	BL	BL
M391	BL	BL	BL	BL	BL
M392	BL	d*1	BL	BL	n.a.
M393	BL	BL	BL	BL	BL
M394	BL	BL	BL	BL	n.a.
M395	d*1	BL	d*1	BL	n.a.
M396	BL	BL	BL	BL	BL
M397	BL	BL	BL	BL	BL
M398	BL	BL	BL	BL	BL
M399	BL	BL	BL	BL	n.a.
M400	BL	BL	BL	BL	BL
M401	BL	BL	BL	BL	n.a.
M402	BL	BL	d*1	BL	n.a.
M403	BL	BL	BL	BL	n.a.
M404	BL	BL	BL	BL	BL
M405	BL	BL	BL	BL	n.a.
M406	BL	BL	BL	BL	d*1
M407	BL	BL	BL	BL	d*1
M408	BL	BL	BL	BL	BL
M409	BL	BL	BL	BL	BL
M410	BL	BL	BL	BL	d*1
M411	BL	BL	BL	BL	BL
M412	BL	BL	BL	BL	BL
M413	BL	BL	BL	BL	d*1
M414	BL	BL	BL	BL	n.a.
M415	BL	BL	BL	BL	n.a.
M416	BL	BL	BL	BL	d*1
M417	BL	BL	BL	BL	BL
M418	BL	BL	BL	BL	n.a.
M419	BL	BL	BL	BL	d*1
M420	BL	BL	BL	BL	BL
M421	BL	BL	BL	BL	n.a.
M422	BL	BL	BL	BL	n.a.
M423	BL	BL	BL	BL	n.a.
M424	BL	BL	BL	BL	d*1

Test Report No.: 244410724a 001

Page 31 of 69

M425	BL	BL	BL	BL	d*1
M426	BL	BL	BL	BL	n.a.
M427	BL	BL	BL	BL	d*1
M428	BL	BL	BL	BL	n.a.
M429	BL	BL	BL	BL	d*1
M430	BL	BL	BL	BL	n.a.
M431	BL	BL	BL	BL	n.a.
M432	BL	BL	BL	BL	BL
M433	BL	BL	BL	BL	n.a.
M434	BL	BL	BL	BL	n.a.
M435	BL	BL	BL	BL	BL
M436	BL	BL	BL	BL	BL
M437	BL	BL	BL	BL	BL
M438	BL	BL	BL	BL	d*1
M439	BL	BL	BL	BL	n.a.
M440	BL	BL	BL	BL	d*1
M441	BL	BL	BL	BL	n.a.
M442	BL	BL	BL	BL	d*1
M443	BL	BL	BL	BL	n.a.
M444	BL	BL	BL	BL	BL
M445	BL	BL	BL	BL	BL
M446	BL	BL	BL	BL	BL
M447	BL	BL	BL	BL	BL
M448	BL	d*1	BL	BL	n.a.
M449	BL	BL	BL	BL	BL
M450	BL	BL	BL	BL	BL
M451	BL	d*1	BL	BL	n.a.
M452	BL	d*1	BL	BL	n.a.
M453	BL	d*1	BL	BL	n.a.
M454	BL	d*1	BL	BL	n.a.
M455	BL	d*1	BL	BL	n.a.
M456	BL	d*1	BL	BL	n.a.
M457	BL	d*1	BL	BL	n.a.
M458	BL	d*1	BL	BL	n.a.
M459	BL	d*1	BL	BL	n.a.
M460	BL	d*1	BL	BL	n.a.
M461	BL	d*1	BL	BL	n.a.
M462	BL	d*1	BL	BL	n.a.
M463	BL	BL	BL	BL	BL
M464	BL	BL	BL	BL	d*1
M465	BL	BL	BL	BL	BL
M466	BL	d*1	BL	BL	n.a.
M467	BL	d*1	BL	BL	n.a.

Test Report No.: 244410724a 001

Page 32 of 69

M468	BL	BL	BL	BL	d*1
M469	BL	BL	BL	BL	BL
M470	BL	BL	BL	BL	n.a.
M471	BL	BL	BL	BL	n.a.
M472	BL	BL	BL	BL	n.a.
M473	BL	BL	BL	BL	n.a.
M474	BL	BL	BL	BL	BL
M475	BL	BL	BL	BL	BL
M476	BL	BL	BL	BL	n.a.
M477	BL	BL	BL	BL	BL
M478	BL	BL	BL	BL	n.a.
M479	BL	BL	BL	BL	BL
M480	BL	BL	BL	BL	BL
M481	BL	BL	BL	BL	BL
M482	BL	d*1	BL	BL	n.a.
M483	BL	BL	BL	BL	BL
M484	BL	BL	BL	BL	d*1
M485	BL	BL	BL	BL	n.a.
M486	BL	d*1	BL	BL	n.a.
M487	BL	d*1	BL	BL	n.a.
M488	BL	BL	BL	BL	n.a.
M489	BL	BL	BL	BL	d*1
M490	BL	BL	BL	BL	BL
M491	BL	BL	BL	BL	BL
M492	BL	BL	BL	BL	BL
M493	BL	BL	BL	BL	n.a.
M494	BL	BL	BL	BL	n.a.
M495	BL	BL	BL	BL	d*1
M496	BL	BL	BL	BL	BL
M497	BL	BL	BL	BL	n.a.
M498	BL	BL	BL	BL	d*1
M499	BL	d*1	BL	BL	n.a.
M500	BL	d*1	BL	BL	n.a.
M501	BL	d*1	BL	BL	n.a.
M502	BL	BL	BL	BL	d*1
M503	BL	BL	BL	BL	n.a.
M504	BL	BL	BL	BL	n.a.
M505	BL	BL	BL	BL	BL
M506	BL	BL	BL	BL	n.a.
M507	BL	BL	BL	BL	BL
M508	BL	BL	BL	BL	BL
M509	BL	BL	BL	BL	BL
M510	BL	BL	BL	BL	n.a.

Test Report No.: 244410724a 001

Page 33 of 69

M511	BL	BL	BL	BL	BL
M512	BL	BL	BL	BL	d*1
M513	BL	BL	BL	BL	BL
M514	BL	BL	BL	BL	n.a.
M515	BL	BL	BL	BL	BL
M516	BL	BL	BL	BL	n.a.
M517	BL	BL	BL	BL	BL
M518	BL	BL	BL	BL	d*1
M519	BL	BL	BL	BL	BL
M520	BL	BL	BL	BL	BL
M521	BL	BL	BL	BL	n.a.
M522	BL	BL	BL	BL	BL
M523	BL	BL	BL	BL	n.a.
M524	BL	BL	BL	BL	n.a.
M525	BL	BL	BL	BL	d*1
M526	BL	BL	BL	BL	d*1
M527	BL	BL	BL	BL	n.a.
M528	BL	BL	BL	BL	n.a.
M529	BL	BL	BL	BL	n.a.
M530	BL	BL	BL	BL	n.a.
M531	BL	BL	BL	BL	d*1
M532	BL	BL	BL	BL	n.a.
M533	BL	BL	BL	BL	d*1
M534	BL	BL	BL	BL	d*1
M535	BL	BL	BL	BL	d*1
M536	BL	BL	BL	BL	n.a.
M537	BL	BL	BL	BL	n.a.
M538	BL	BL	BL	BL	n.a.
M539	BL	BL	BL	BL	BL
M540	BL	BL	BL	BL	BL
M541	BL	BL	BL	BL	d*1
M542	BL	BL	BL	BL	n.a.
M543	BL	BL	BL	BL	BL
M544	BL	BL	BL	BL	d*1
M545	BL	BL	BL	BL	n.a.
M546	BL	BL	BL	BL	d*1
M547	BL	BL	BL	BL	d*1
M548	BL	BL	BL	BL	n.a.
M549	BL	BL	BL	BL	d*1
M550	BL	BL	BL	BL	n.a.
M551	BL	BL	BL	BL	n.a.
M552	BL	BL	BL	BL	n.a.
M553	BL	BL	BL	BL	d*1

Test Report No.: 244410724a 001

Page 34 of 69

M554	BL	BL	BL	BL	n.a.
M555	BL	BL	BL	BL	n.a.
M556	BL	BL	BL	BL	BL
M557	BL	BL	BL	BL	n.a.
M558	BL	BL	BL	BL	BL
M559	BL	BL	BL	BL	n.a.
M560	BL	BL	BL	BL	BL
M561	BL	BL	BL	BL	d*1
M562	BL	BL	BL	BL	d*1
M563	BL	BL	BL	BL	n.a.
M564	BL	BL	BL	BL	d*1
M565	BL	BL	BL	BL	n.a.
M566	BL	BL	d*1	BL	n.a.
M567	BL	BL	BL	BL	n.a.
M568	BL	BL	BL	BL	d*1
M569	BL	BL	BL	BL	n.a.

Abbreviation:

Pb	=	Lead
Cd	=	Cadmium
Hg	=	Mercury
Cr	=	Chromium
Br	=	Bromine
n.a.	=	Not applicable
BL	=	Below limit
OL	=	Over limit
d.	=	Detected

Test Report No.: 244410724a 001

Page 35 of 69

Remark:

- (*1) The screening result was found in the inconclusive region, thus the further wet chemistry tests are suggested.
- (*2) Component(s)/ materials(s) with an area of less than 2mm x2 mm will not be selected for testing according to RoHS Directive 2011/65/EU due to technical reason.
For the test sample does not have detail materials information provided by client, visually identical materials (e.g. wire insulation, solder points, etc.) will be considered as the same material.
Solder points on a printing circuit board will be examined several times based on optical anomalies or discoloration of the solder point(s) unless the solder point(s) is obviously generated automatically during production.
All other materials will be sampled and tested at one test point representatively.
- (*3) The Chromium (Cr) and Bromine (Br) in the above result table indicate the total chromium and total bromine by means of XRF screening.
PBBs, or PBDEs content shall be further confirmed with reference to IEC 62321-6:2015.
Chromium (VI) shall be further confirmed with reference to IEC 62321-7-1:2015, IEC 62321-7-2:2017 or EN ISO 17075-1:2017.

XRF Screening limits for different matrices :

Material	Concentration (%)				
	Cd	Cr	Pb	Hg	Br
Polymeric	BL≤0.006<X<0.014≤ OL	BL≤0.064<X	BL≤0.067<X<0.133≤ OL	BL≤0.066<X< 0.134≤OL	BL≤0.029<X
Metallic	BL≤0.006<X<0.014≤ OL	BL≤0.064<X	BL≤0.067<X<0.133≤ OL	BL≤0.066<X< 0.134≤OL	n.a.
Composite materials	BL≤0.004<X<0.016≤ OL	BL≤0.044<X	BL≤0.047<X<0.153≤ OL	BL≤0.046<X< 0.154≤OL	BL≤0.024<X

Remark: The symbol "X" marks the region where further investigation is necessary.

Test Report No.: 244410724a 001

Page 36 of 69

Cadmium, Lead, Chromium (VI), Mercury, Polybrominated biphenyls (PBB) and Polybrominated diphenyl ethers (PBDE)

Test Method: Total Cadmium, Lead, Mercury, Chromium
- Ref. to IEC 62321-4:2013+AMD1:2017 and IEC 62321-5:2013

Chromium (VI)
- For Metal material - Ref. to IEC 62321-7-1:2015
- For Plastic or Electronic material - Ref. to IEC 62321-7-2:2017
- For Leather material - Ref. to EN ISO 17075-1:2017

PBBs, PBDEs - Ref. to IEC 62321-6:2015

Test Result:

	Cd	Cr(VI)	Pb	Hg	PBBs (*)	PBDEs (*)
Maximum Permissible Limit (%)	0.01	0.1	0.1	0.1	0.1	0.1

Material No.	(%)					
	Cd	Cr^{VI}	Pb	Hg	PBBs (*)	PBDEs (*)
	RL (%)					
	0.001	0.001	0.001	0.001	0.01	0.01
M008	n.a.	n.a.	n.a.	n.a.	< RL	< RL
M011	n.a.	n.a.	n.a.	n.a.	< RL	< RL
M020	n.a.	n.a.	n.a.	n.a.	< RL	< RL
M021	n.a.	n.a.	n.a.	n.a.	< RL	< RL
M035	n.a.	n.a.	n.a.	n.a.	< RL	< RL
M040	n.a.	n.a.	n.a.	n.a.	< RL	< RL
M054	n.a.	n.a.	n.a.	n.a.	< RL	< RL
M056	n.a.	n.a.	n.a.	n.a.	< RL	< RL
M060	n.a.	n.a.	n.a.	n.a.	< RL	< RL
M063	n.a.	n.a.	47.8 7(c)-I	n.a.	n.a.	n.a.
M066	n.a.	n.a.	3.97 7(c)-I	n.a.	n.a.	n.a.
M069	n.a.	n.a.	n.a.	n.a.	< RL	< RL
M077	n.a.	n.a.	n.a.	n.a.	< RL	< RL
M080	n.a.	n.a.	n.a.	n.a.	< RL	< RL
M083	n.a.	n.a.	n.a.	n.a.	< RL	< RL
M086	n.a.	n.a.	n.a.	n.a.	< RL	< RL
M097	n.a.	n.a.	n.a.	n.a.	< RL	< RL
M098	n.a.	n.a.	n.a.	n.a.	< RL	< RL

Test Report No.: 244410724a 001

Page 37 of 69

M101	n.a.	n.a.	n.a.	n.a.	< RL	< RL
M102	n.a.	n.a.	n.a.	n.a.	< RL	< RL
M104	n.a.	n.a.	n.a.	n.a.	< RL	< RL
M105	n.a.	n.a.	n.a.	n.a.	< RL	< RL
M109	n.a.	n.a.	n.a.	n.a.	< RL	< RL
M114	n.a.	n.a.	n.a.	n.a.	< RL	< RL
M137	n.a.	n.a.	n.a.	n.a.	< RL	< RL
M146	n.a.	n.a.	n.a.	n.a.	< RL	< RL
M160	n.a.	n.a.	n.a.	n.a.	< RL	< RL
M161	n.a.	n.a.	n.a.	n.a.	< RL	< RL
M172	n.a.	n.a.	n.a.	n.a.	< RL	< RL
M175	n.a.	n.a.	n.a.	n.a.	< RL	< RL
M178	n.a.	n.a.	n.a.	n.a.	< RL	< RL
M181	n.a.	n.a.	n.a.	n.a.	< RL	< RL
M182	n.a.	n.a.	n.a.	n.a.	< RL	< RL
M185	n.a.	n.a.	n.a.	n.a.	< RL	< RL
M188	n.a.	n.a.	n.a.	n.a.	< RL	< RL
M190	n.a.	n.a.	n.a.	n.a.	< RL	< RL
M195	n.a.	n.a.	n.a.	n.a.	< RL	< RL
M205	n.a.	n.a.	n.a.	n.a.	< RL	< RL
M207	n.a.	n.a.	38.9 7(c)-I	n.a.	n.a.	n.a.
M253	n.a.	n.a.	n.a.	n.a.	< RL	< RL
M257	n.a.	n.a.	n.a.	n.a.	< RL	< RL
M262	n.a.	n.a.	n.a.	n.a.	< RL	< RL
M266	n.a.	n.a.	n.a.	n.a.	< RL	< RL
M271	n.a.	n.a.	n.a.	n.a.	< RL	< RL
M289	n.a.	n.a.	n.a.	n.a.	< RL	< RL
M292	n.a.	n.a.	n.a.	n.a.	< RL	< RL
M294	n.a.	n.a.	n.a.	n.a.	< RL	< RL
M295	n.a.	n.a.	n.a.	n.a.	< RL	< RL
M296	n.a.	n.a.	n.a.	n.a.	< RL	< RL
M300	n.a.	n.a.	n.a.	n.a.	< RL	< RL
M305	n.a.	n.a.	n.a.	n.a.	< RL	< RL
M317	n.a.	n.a.	n.a.	n.a.	< RL	< RL
M321	n.a.	n.a.	n.a.	n.a.	< RL	< RL
M324	n.a.	n.a.	n.a.	n.a.	< RL	< RL

Test Report No.: 244410724a 001

Page 38 of 69

M326	n.a.	n.a.	n.a.	n.a.	< RL	< RL
M329	n.a.	n.a.	0.330 7(c)-I	n.a.	n.a.	n.a.
M331	n.a.	n.a.	n.a.	n.a.	< RL	< RL
M334	n.a.	n.a.	n.a.	n.a.	< RL	< RL
M337	< RL	n.a.	61.6 7(c)-I	n.a.	n.a.	n.a.
M340	n.a.	n.a.	n.a.	n.a.	< RL	< RL
M342	n.a.	n.a.	n.a.	n.a.	< RL	< RL
M344	n.a.	n.a.	n.a.	n.a.	< RL	< RL
M349	n.a.	n.a.	n.a.	n.a.	< RL	< RL
M358	n.a.	n.a.	n.a.	n.a.	< RL	< RL
M360	n.a.	n.a.	n.a.	n.a.	< RL	< RL
M371	n.a.	n.a.	n.a.	n.a.	< RL	< RL
M395	< RL	n.a.	65.2 7(c)-I	n.a.	n.a.	n.a.
M402	n.a.	n.a.	0.316 7(c)-I	n.a.	n.a.	n.a.
M406	n.a.	n.a.	n.a.	n.a.	< RL	< RL
M407	n.a.	n.a.	n.a.	n.a.	< RL	< RL
M410	n.a.	n.a.	n.a.	n.a.	< RL	< RL
M413	n.a.	n.a.	n.a.	n.a.	< RL	< RL
M416	n.a.	n.a.	n.a.	n.a.	< RL	< RL
M419	n.a.	n.a.	n.a.	n.a.	< RL	< RL
M424	n.a.	n.a.	n.a.	n.a.	< RL	< RL
M425	n.a.	n.a.	n.a.	n.a.	< RL	< RL
M427	n.a.	n.a.	n.a.	n.a.	< RL	< RL
M429	n.a.	n.a.	n.a.	n.a.	< RL	< RL
M438	n.a.	n.a.	n.a.	n.a.	< RL	< RL
M440	n.a.	n.a.	n.a.	n.a.	< RL	< RL
M442	n.a.	n.a.	n.a.	n.a.	< RL	< RL
M464	n.a.	n.a.	n.a.	n.a.	< RL	< RL
M468	n.a.	n.a.	n.a.	n.a.	< RL	< RL
M484	n.a.	n.a.	n.a.	n.a.	< RL	< RL
M489	n.a.	n.a.	n.a.	n.a.	< RL	< RL
M495	n.a.	n.a.	n.a.	n.a.	< RL	< RL
M498	n.a.	n.a.	n.a.	n.a.	< RL	< RL
M502	n.a.	n.a.	n.a.	n.a.	< RL	< RL
M512	n.a.	n.a.	n.a.	n.a.	< RL	< RL
M518	n.a.	n.a.	n.a.	n.a.	< RL	< RL

Test Report No.: 244410724a 001

Page 39 of 69

M525	n.a.	n.a.	n.a.	n.a.	< RL	< RL
M526	n.a.	n.a.	n.a.	n.a.	< RL	< RL
M531	n.a.	n.a.	n.a.	n.a.	< RL	< RL
M533	n.a.	n.a.	n.a.	n.a.	< RL	< RL
M534	n.a.	n.a.	n.a.	n.a.	< RL	< RL
M535	n.a.	n.a.	n.a.	n.a.	< RL	< RL
M541	n.a.	n.a.	n.a.	n.a.	< RL	< RL
M544	n.a.	n.a.	n.a.	n.a.	< RL	< RL
M546	n.a.	n.a.	n.a.	n.a.	< RL	< RL
M547	n.a.	n.a.	n.a.	n.a.	< RL	< RL
M549	n.a.	n.a.	n.a.	n.a.	< RL	< RL
M553	n.a.	n.a.	n.a.	n.a.	< RL	< RL
M561	n.a.	n.a.	n.a.	n.a.	< RL	< RL
M562	n.a.	n.a.	n.a.	n.a.	< RL	< RL
M564	n.a.	n.a.	n.a.	n.a.	< RL	< RL
M566	n.a.	n.a.	0.363 7(c)-I	n.a.	n.a.	n.a.
M568	n.a.	n.a.	n.a.	n.a.	< RL	< RL

Material No.	Hexavalent Chromium Content ($\mu\text{g}/\text{cm}^2$) (*1) RL: 0.10 $\mu\text{g}/\text{cm}^2$
M019	Negative
M022	Negative
M024	Negative
M031	Negative
M037	Negative
M046	Negative
M048	Negative
M049	Negative
M050	Negative
M051	Negative
M052	Negative
M053	Negative
M143	Negative
M147	Negative
M148	Negative
M149	Negative
M150	Negative
M151	Negative

Test Report No.: 244410724a 001

Page 40 of 69

M153	Negative
M157	Negative
M164	Negative
M199	Negative
M226	Negative
M227	Negative
M228	Negative
M229	Negative
M230	Negative
M231	Negative
M232	Negative
M233	Negative
M234	Negative
M235	Negative
M236	Negative
M237	Negative
M238	Negative
M239	Negative
M240	Negative
M241	Negative
M242	Negative
M243	Negative
M250	Negative
M256	Negative
M259	Negative
M261	Negative
M263	Negative
M264	Negative
M267	Negative
M319	Negative
M320	Negative
M372	Negative
M374	Negative
M375	Negative
M376	Negative
M377	Negative
M378	Negative
M379	Negative
M380	Negative
M381	Negative
M382	Negative

Test Report No.: 244410724a 001

Page 41 of 69

M383	Negative
M384	Negative
M385	Negative
M392	Negative
M448	Negative
M451	Negative
M452	Negative
M453	Negative
M454	Negative
M455	Negative
M456	Negative
M457	Negative
M458	Negative
M459	Negative
M460	Negative
M461	Negative
M462	Negative
M466	Negative
M467	Negative
M482	Negative
M486	Negative
M487	Negative
M499	Negative
M500	Negative
M501	Negative
Material No.	Hexavalent Chromium Content (%) (*2) RL: 0.01%
M275	< RL

Abbreviation:

Pb	= Lead
Cd	= Cadmium
Hg	= Mercury
Cr	= Chromium
Cr (VI)	= Chromium (VI)
PBBs	= Total Polybrominated Biphenyls
PBDEs	= Total Polybrominated Diphenyl Ethers
<	= Less than
RL	= Reporting Limit
n.a.	= Not Applicable
^	= The total Chromium have been determined
%	= Percentage

Test Report No.: 244410724a 001

Page 42 of 69

Remark:

(*) The reporting limit for each individual PBBs and individual PBDEs are :

Reporting Limit (%)		
PBBs	Bromobiphenyl	0.01
	Dibromobiphenyl	0.01
	Tribromobiphenyl	0.01
	Tetrabromobiphenyl	0.01
	Pentabromobiphenyl	0.01
	Hexabromobiphenyl	0.01
	Heptabromobiphenyl	0.01
	Octabromobiphenyl	0.01
	Nonabromobiphenyl	0.01
	Decabromobiphenyl	0.01
PBDEs	Bromodiphenylether	0.01
	Dibromodiphenyl ether	0.01
	Tribromodiphenyl ether	0.01
	Tetrabromodiphenyl ether	0.01
	Pentabromodiphenyl ether	0.01
	Hexabromodiphenyl ether	0.01
	Heptabromodiphenyl ether	0.01
	Octabromodiphenyl ether	0.01
	Nonabromodiphenyl ether	0.01
	Decabromodiphenyl ether	0.01

(*1) The total chromium content in Metal sample was found to be exceeded the maximum permissible limit (0.1%). Thus, the Chromium (VI) content in surface layer have been confirmed with reference to IEC 62321-7-1:2015 Annex.

	Chromium (VI) concentration	Qualitative result
Negative	$<0.1\mu\text{g}/\text{cm}^2$	The sample is negative (-ve) for Cr(VI). The Cr(VI) concentration is below the limit of quantification. The coating is considered a non-Cr(VI) based coating
Inconclusive	$\geq 0.1\mu\text{g}/\text{cm}^2$ and $\leq 0.13\mu\text{g}/\text{cm}^2$	The result is considered to be inconclusive. Unavoidable coating variations may influence the determination. Recommendation: if additional samples are available, perform a total of 3 trials to increase sampling surface area. Use the averaged result of the 3 trials for the final determination.
Positive	$>0.13\mu\text{g}/\text{cm}^2$	The sample is positive (+ve) for Cr(VI). Concentration is above the limit of quantification and the statistical margin of error. The sample coating is considered to contain Cr(VI).

7(c)-I Denotes exemption applications 7(c)-I Electrical and electronic components containing lead in a glass or ceramic other than dielectric ceramic in capacitors, e.g. piezoelectronic devices, or in a glass or ceramic matrix compound.

Test Report No.: 244410724a 001

Page 43 of 69

- (*2) The total chromium content in plastic sample or electronic sample was found to be exceeded the maximum permissible limit (0.1%). Thus, the Chromium (VI) content have been confirmed with reference to IEC 62321-7-2:2017.

Test Report No.: 244410724a 001

Page 44 of 69

BBP, DBP, DEHP, DIBP content

Test Method: IEC 62321-8:2017

Test Result:

	BBP	DBP	DEHP	DIBP
Maximum permissible Limit (%)	0.1	0.1	0.1	0.1

Test No.	Material No.	RL (%)			
		0.005			
		BBP	DBP	DEHP	DIBP
		0.005			
T001	M002 + M008 + M021	< RL	< RL	< RL	< RL
T002	M003	< RL	< RL	< RL	< RL
T003	M005	< RL	< RL	< RL	< RL
T004	M006	< RL	< RL	< RL	< RL
T005	M007	< RL	< RL	< RL	< RL
T006	M009	< RL	< RL	< RL	< RL
T007	M010	< RL	< RL	< RL	< RL
T008	M011	< RL	< RL	< RL	< RL
T009	M012	< RL	< RL	< RL	< RL
T010	M013	< RL	< RL	< RL	< RL
T011	M015	< RL	< RL	< RL	< RL
T012	M018	< RL	< RL	< RL	< RL
T013	M020	< RL	< RL	< RL	< RL
T014	M027	< RL	< RL	< RL	< RL
T015	M028 + M035 + M040	< RL	< RL	< RL	< RL
T016	M029	< RL	< RL	< RL	< RL
T017	M032	< RL	< RL	< RL	< RL
T018	M033	< RL	< RL	< RL	< RL
T019	M036	< RL	< RL	< RL	< RL
T020	M039	< RL	< RL	< RL	< RL
T021	M041	< RL	< RL	< RL	< RL
T022	M042	< RL	< RL	< RL	< RL
T023	M054 + M078 + M097	< RL	< RL	< RL	< RL
T024	M056 + M058 + M060	< RL	< RL	< RL	< RL

Test Report No.: 244410724a 001

Page 45 of 69

T025	M057	< RL	< RL	< RL	< RL
T026	M059	< RL	< RL	< RL	< RL
T027	M061	< RL	< RL	< RL	< RL
T028	M069 + M077 + M086	< RL	< RL	< RL	< RL
T029	M071	< RL	< RL	< RL	< RL
T030	M074	< RL	< RL	< RL	< RL
T031	M076	< RL	< RL	< RL	< RL
T032	M080	< RL	< RL	< RL	< RL
T033	M083	< RL	< RL	< RL	< RL
T034	M084	< RL	< RL	< RL	< RL
T035	M085	< RL	< RL	< RL	< RL
T036	M089	< RL	< RL	< RL	< RL
T037	M090 + M091 + M098	< RL	< RL	< RL	< RL
T038	M099 + M100 + M101	< RL	< RL	< RL	< RL
T039	M102 + M103 + M104	< RL	< RL	< RL	< RL
T040	M105 + M109 + M116	< RL	< RL	< RL	< RL
T041	M107	< RL	< RL	< RL	< RL
T042	M114	< RL	< RL	< RL	< RL
T043	M115	< RL	< RL	< RL	< RL
T044	M119 + M121 + M125	< RL	< RL	< RL	< RL
T045	M123	< RL	< RL	< RL	< RL
T046	M124	< RL	< RL	< RL	< RL
T047	M126	< RL	< RL	< RL	< RL
T048	M127	< RL	< RL	< RL	< RL
T049	M129	< RL	< RL	< RL	< RL
T050	M131 + M133 + M136	< RL	< RL	< RL	< RL
T051	M137 + M001 + M043	< RL	< RL	< RL	< RL
T052	M140 + M144 + M146	< RL	< RL	< RL	< RL
T053	M141	< RL	< RL	< RL	< RL
T054	M142	< RL	< RL	< RL	< RL
T055	M145	< RL	< RL	< RL	< RL
T056	M154	< RL	< RL	< RL	< RL
T057	M156	< RL	< RL	< RL	< RL

Test Report No.: 244410724a 001

Page 46 of 69

T058	M158	< RL	< RL	< RL	< RL
T059	M160 + M205	< RL	< RL	< RL	< RL
T060	M161 + M175 + M178	< RL	< RL	< RL	< RL
T061	M166	< RL	< RL	< RL	< RL
T062	M168	< RL	< RL	< RL	< RL
T063	M170	< RL	< RL	< RL	< RL
T064	M171	< RL	< RL	< RL	< RL
T065	M172	< RL	< RL	< RL	< RL
T066	M173	< RL	< RL	< RL	< RL
T067	M174	< RL	< RL	< RL	< RL
T068	M176	< RL	< RL	< RL	< RL
T069	M177	< RL	< RL	< RL	< RL
T070	M181 + M182 + M185	< RL	< RL	< RL	< RL
T071	M188 + M190 + M195	< RL	< RL	< RL	< RL
T072	M192	< RL	< RL	< RL	< RL
T073	M193	< RL	< RL	< RL	< RL
T074	M197	< RL	< RL	< RL	< RL
T075	M198	< RL	< RL	< RL	< RL
T076	M200	< RL	< RL	< RL	< RL
T077	M202	< RL	< RL	< RL	< RL
T078	M208	< RL	< RL	< RL	< RL
T079	M209	< RL	< RL	< RL	< RL
T080	M211 + M212	< RL	< RL	< RL	< RL
T081	M214	< RL	< RL	< RL	< RL
T082	M216 + M217 + M224	< RL	< RL	< RL	< RL
T083	M218	< RL	< RL	< RL	< RL
T084	M220	< RL	< RL	< RL	< RL
T085	M221	< RL	< RL	< RL	< RL
T086	M223	< RL	< RL	< RL	< RL
T087	M245	< RL	< RL	< RL	< RL
T088	M247	< RL	< RL	< RL	< RL
T089	M248	< RL	< RL	< RL	< RL
T090	M249	< RL	< RL	< RL	< RL
T091	M251 + M253 + M257	< RL	< RL	< RL	< RL

Test Report No.: 244410724a 001

Page 47 of 69

T092	M252	< RL	< RL	< RL	< RL
T093	M254	< RL	< RL	< RL	< RL
T094	M258	< RL	< RL	< RL	< RL
T095	M262	< RL	< RL	< RL	< RL
T096	M266 + M288 + M289	< RL	< RL	< RL	< RL
T097	M268	< RL	< RL	< RL	< RL
T098	M269	< RL	< RL	< RL	< RL
T099	M270	< RL	< RL	< RL	< RL
T100	M271 + M358 + M360	< RL	< RL	< RL	< RL
T101	M272	< RL	< RL	< RL	< RL
T102	M273	< RL	< RL	< RL	< RL
T103	M274	< RL	< RL	< RL	< RL
T104	M280	< RL	< RL	< RL	< RL
T105	M281	< RL	< RL	< RL	< RL
T106	M286	< RL	< RL	< RL	< RL
T107	M287	< RL	< RL	< RL	< RL
T108	M290	< RL	< RL	< RL	< RL
T109	M292 + M294 + M295	< RL	< RL	< RL	< RL
T110	M296 + M301 + M302	< RL	< RL	< RL	< RL
T111	M300	< RL	< RL	< RL	< RL
T112	M305 + M309 + M310	< RL	< RL	< RL	< RL
T113	M307	< RL	< RL	< RL	< RL
T114	M308	< RL	< RL	< RL	< RL
T115	M313	< RL	< RL	< RL	< RL
T116	M314 + M316 + M317	< RL	< RL	< RL	< RL
T117	M321 + M323 + M324	< RL	< RL	< RL	< RL
T118	M326 + M340 + M342	< RL	< RL	< RL	< RL
T119	M327	< RL	< RL	< RL	< RL
T120	M331	< RL	< RL	< RL	< RL
T121	M332	< RL	< RL	< RL	< RL
T122	M333	< RL	< RL	< RL	< RL
T123	M334	< RL	< RL	< RL	< RL
T124	M335	< RL	< RL	< RL	< RL

Test Report No.: 244410724a 001

Page 48 of 69

T125	M336	< RL	< RL	< RL	< RL
T126	M344 + M349 + M352	< RL	< RL	< RL	< RL
T127	M347	< RL	< RL	< RL	< RL
T128	M350	< RL	< RL	< RL	< RL
T129	M355	< RL	< RL	< RL	< RL
T130	M356	< RL	< RL	< RL	< RL
T131	M357	< RL	< RL	< RL	< RL
T132	M361	< RL	< RL	< RL	< RL
T133	M364 + M366 + M371	< RL	< RL	< RL	< RL
T134	M365	< RL	< RL	< RL	< RL
T135	M367 + M446 + M445	< RL	< RL	< RL	< RL
T136	M369	< RL	< RL	< RL	< RL
T137	M370	< RL	< RL	< RL	< RL
T138	M386	< RL	< RL	< RL	< RL
T139	M388	< RL	< RL	< RL	< RL
T140	M390	< RL	< RL	< RL	< RL
T141	M391	< RL	< RL	< RL	< RL
T142	M393	< RL	< RL	< RL	< RL
T143	M396	< RL	< RL	< RL	< RL
T144	M397	< RL	< RL	< RL	< RL
T145	M398	< RL	< RL	< RL	< RL
T146	M400 + M404 + M406	< RL	< RL	< RL	< RL
T147	M407	< RL	< RL	< RL	< RL
T148	M408	< RL	< RL	< RL	< RL
T149	M409	< RL	< RL	< RL	< RL
T150	M410 + M413 + M416	< RL	< RL	< RL	< RL
T151	M411	< RL	< RL	< RL	< RL
T152	M412	< RL	< RL	< RL	< RL
T153	M417	< RL	< RL	< RL	< RL
T154	M419	< RL	< RL	< RL	< RL
T155	M420	< RL	< RL	< RL	< RL
T156	M424 + M425 + M427	< RL	< RL	< RL	< RL
T157	M429 + M437 + M440	< RL	< RL	< RL	< RL

Test Report No.: 244410724a 001

Page 49 of 69

T158	M432	< RL	< RL	< RL	< RL
T159	M435	< RL	< RL	< RL	< RL
T160	M436	< RL	< RL	< RL	< RL
T161	M438 + M442	< RL	< RL	< RL	< RL
T162	M444	< RL	< RL	< RL	< RL
T163	M445 + M447 + M464	< RL	< RL	< RL	< RL
T164	M449	< RL	< RL	< RL	< RL
T165	M450	< RL	< RL	< RL	< RL
T166	M463	< RL	< RL	< RL	< RL
T167	M465	< RL	< RL	< RL	< RL
T168	M468 + M472 + M484	< RL	< RL	< RL	< RL
T169	M469	< RL	< RL	< RL	< RL
T170	M474	< RL	< RL	< RL	< RL
T171	M475	< RL	< RL	< RL	< RL
T172	M477	< RL	< RL	< RL	< RL
T173	M479	< RL	< RL	< RL	< RL
T174	M480	< RL	< RL	< RL	< RL
T175	M481	< RL	< RL	< RL	< RL
T176	M483	< RL	< RL	< RL	< RL
T177	M489 + M502 + M511	< RL	< RL	< RL	< RL
T178	M490	< RL	< RL	< RL	< RL
T179	M491	< RL	< RL	< RL	< RL
T180	M492	< RL	< RL	< RL	< RL
T181	M496	< RL	< RL	< RL	< RL
T182	M498	< RL	< RL	< RL	< RL
T183	M505	< RL	< RL	< RL	< RL
T184	M507	< RL	< RL	< RL	< RL
T185	M508	< RL	< RL	< RL	< RL
T186	M509	< RL	< RL	< RL	< RL
T187	M512 + M520 + M525	< RL	< RL	< RL	< RL
T188	M513	< RL	< RL	< RL	< RL
T189	M515	< RL	< RL	< RL	< RL
T190	M517	< RL	< RL	< RL	< RL
T191	M518	< RL	< RL	< RL	< RL

Test Report No.: 244410724a 001

Page 50 of 69

T192	M519	< RL	< RL	< RL	< RL
T193	M522	< RL	< RL	< RL	< RL
T194	M526 + M527 + M531	< RL	< RL	< RL	< RL
T195	M528	< RL	< RL	< RL	< RL
T196	M533 + M534 + M535	< RL	< RL	< RL	< RL
T197	M536 + M539 + M540	< RL	< RL	< RL	< RL
T198	M541 + M543 + M544	< RL	< RL	< RL	< RL
T199	M546 + M547 + M549	< RL	< RL	< RL	< RL
T200	M553 + M561 + M495	< RL	< RL	< RL	< RL
T201	M556	< RL	< RL	< RL	< RL
T202	M558	< RL	< RL	< RL	< RL
T203	M560	< RL	< RL	< RL	< RL
T204	M562 + M564 + M568	< RL	< RL	< RL	< RL

Abbreviation: BBP= Benzylbutyl phthalate
 DBP= Dibutyl phthalate
 DEHP= Bis(2-ethylhexyl) phthalate
 DIBP= Diisobutyl phthalate
 < = less than
 RL = Reporting Limit
 N.A. = Not Applicable
 %= percentage

Sample Photos

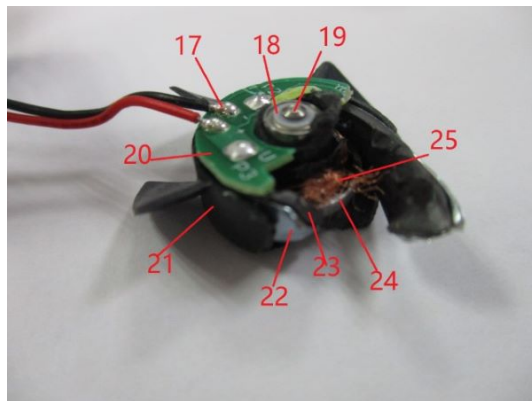
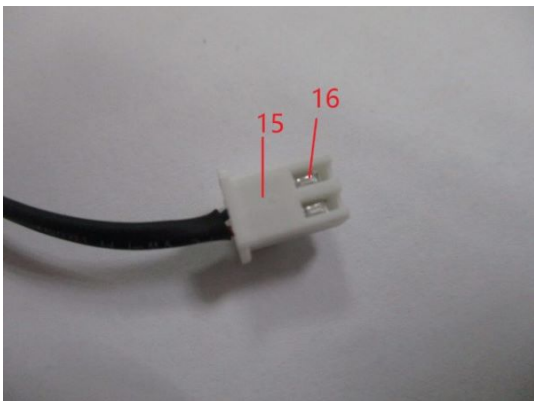
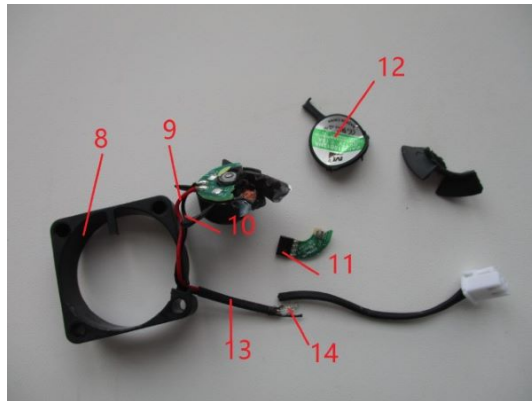
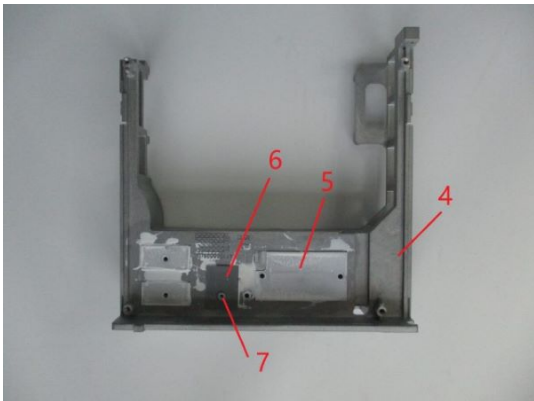

Sample Photos

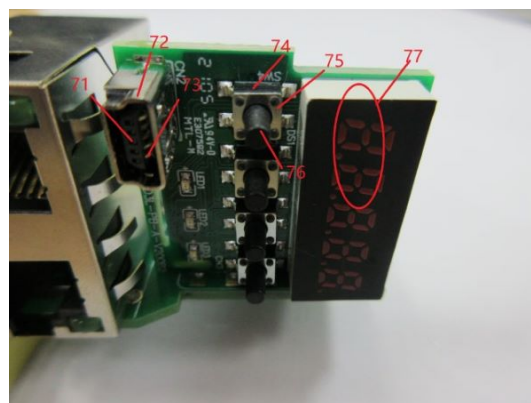
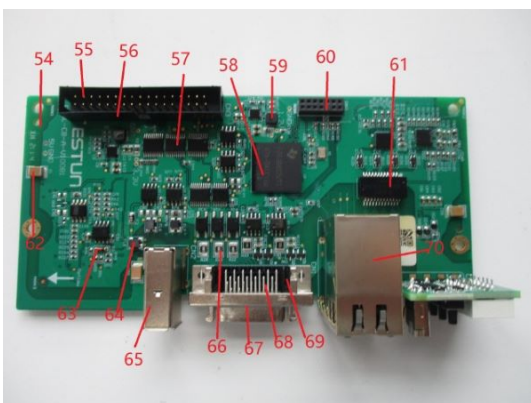
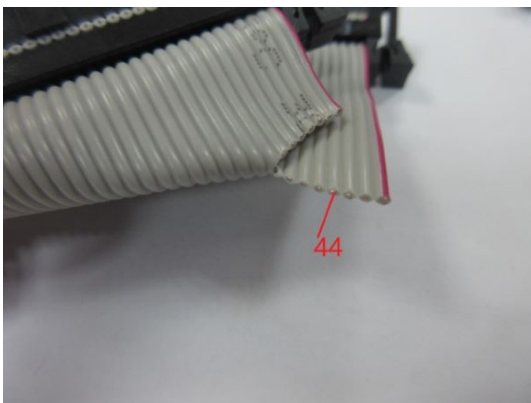
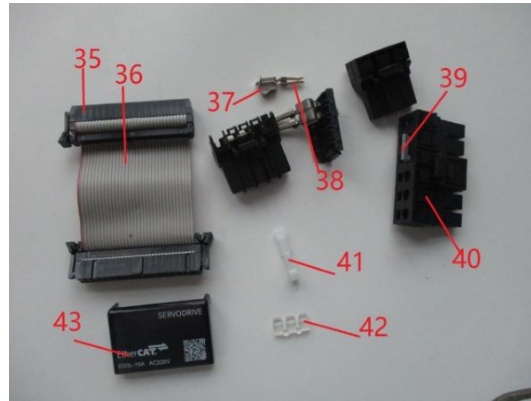
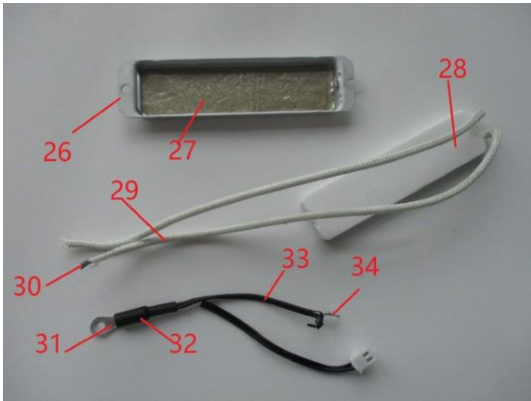

Sample Photos

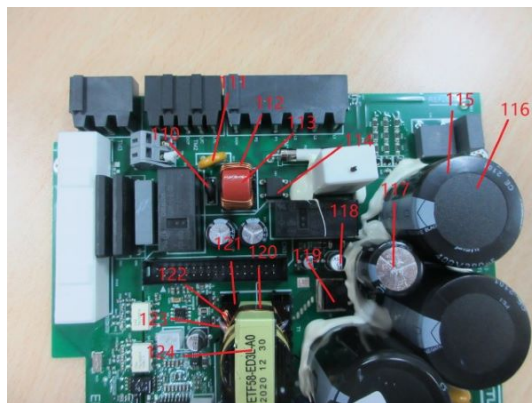
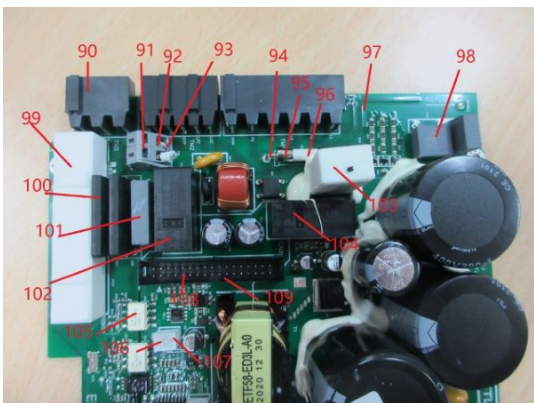
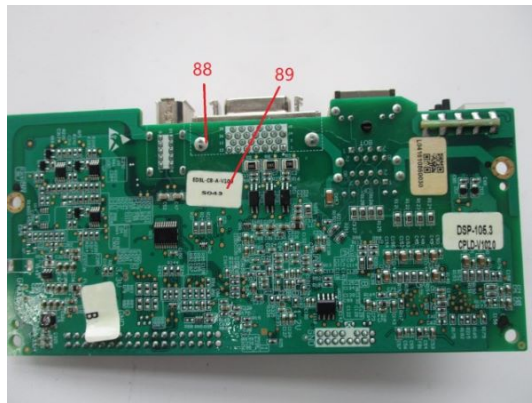
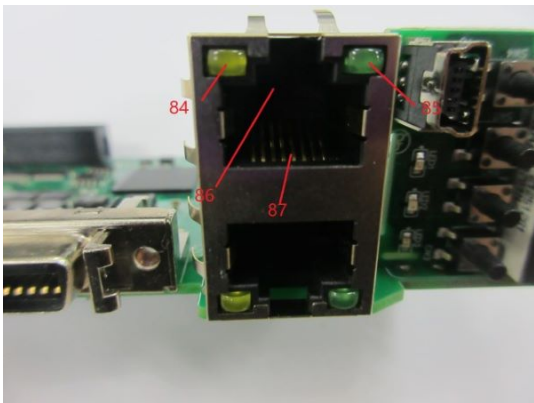
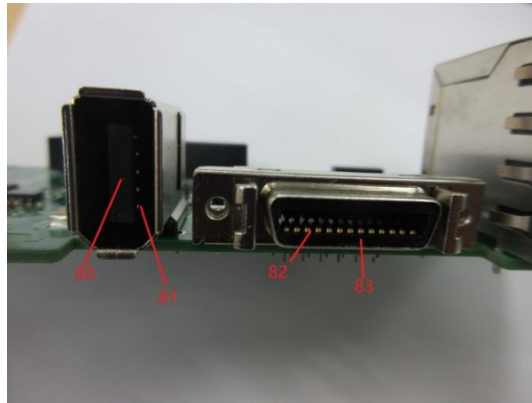
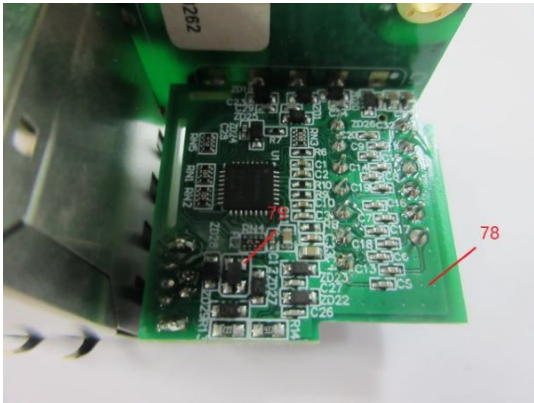

Sample Photos

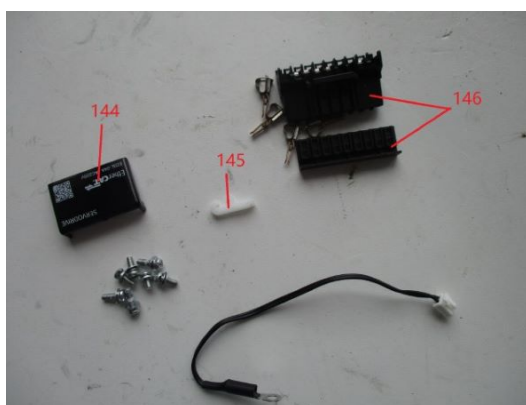
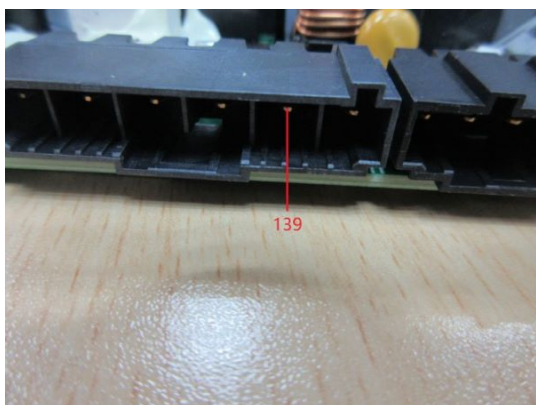
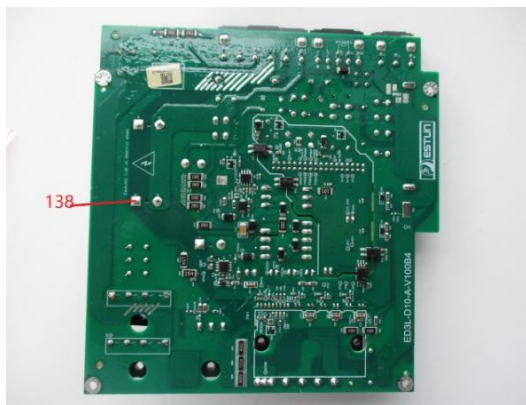

Sample Photos

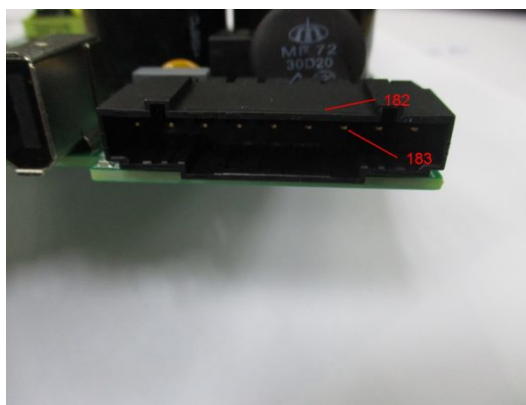
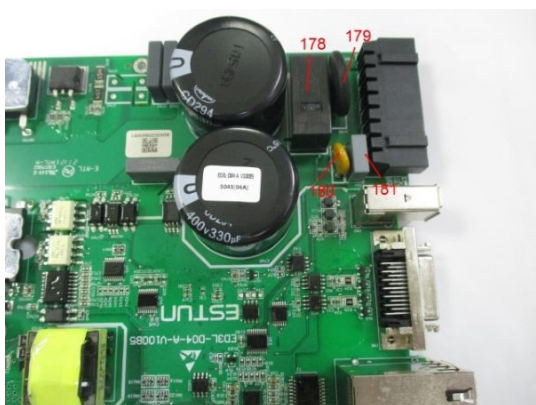
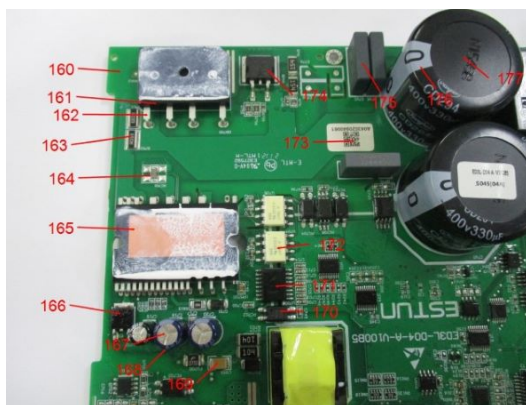
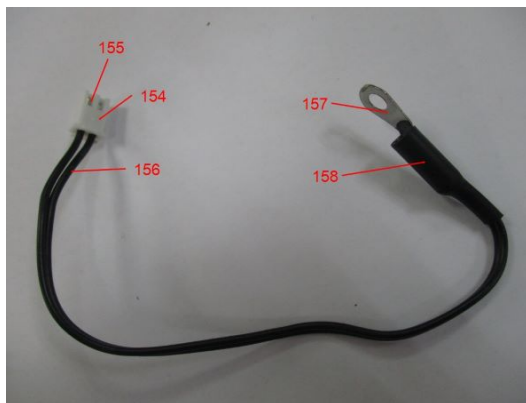

Sample Photos

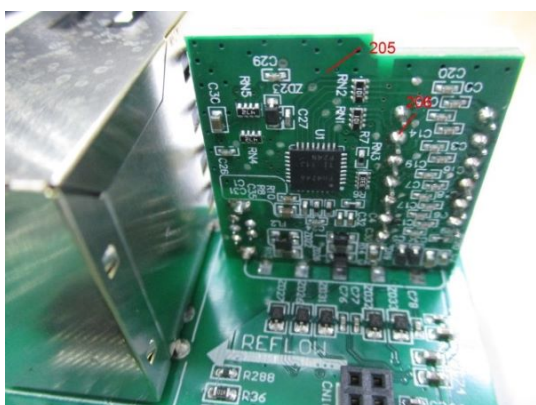
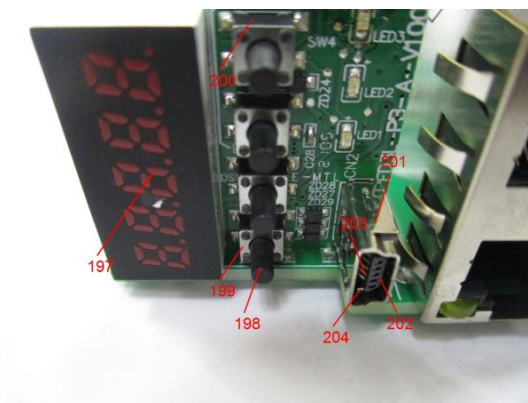
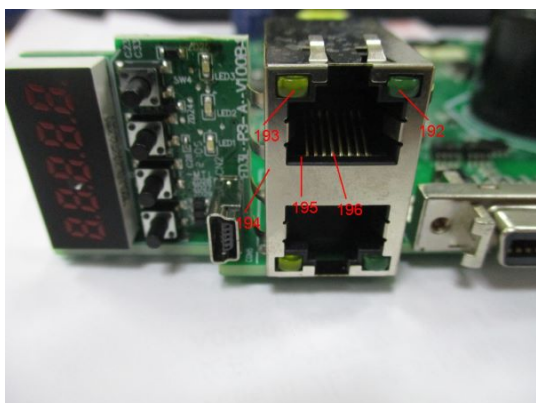
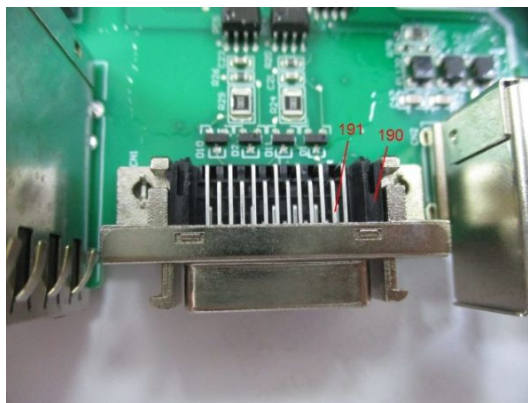
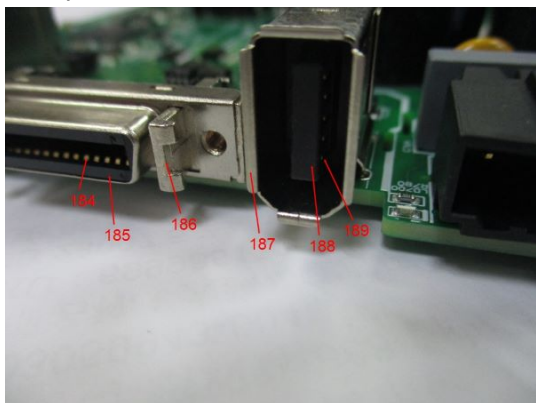

Sample Photos

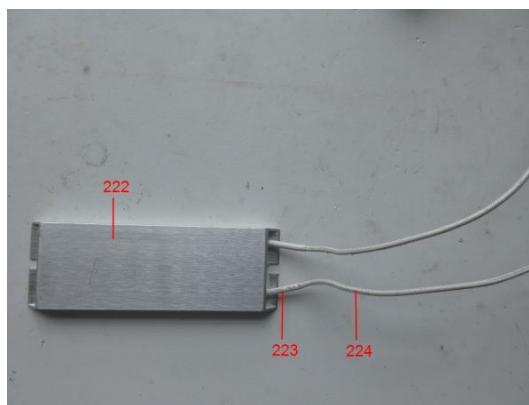
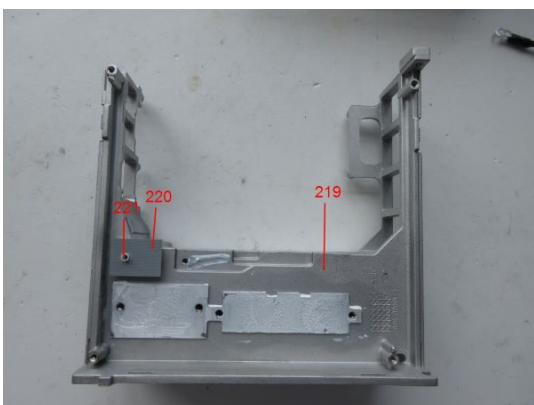
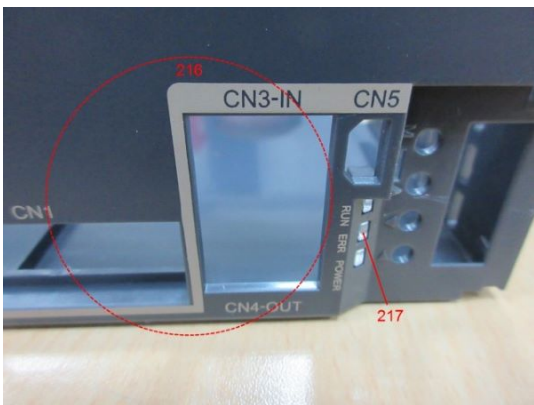
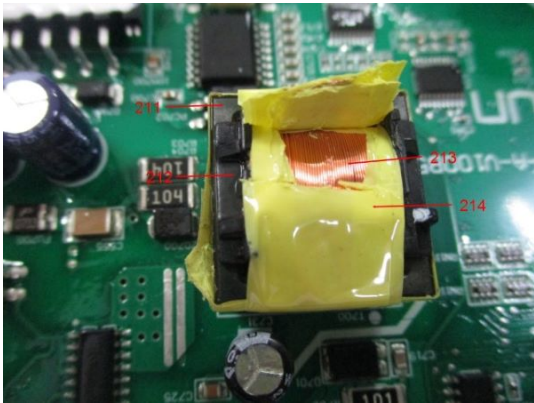

Sample Photos

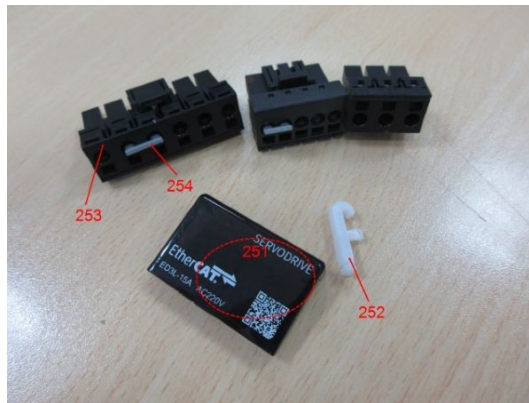
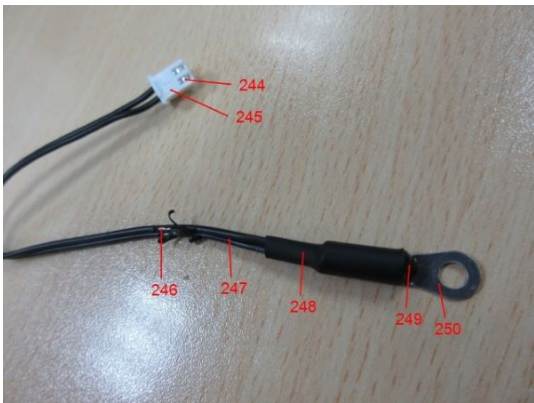

Sample Photos

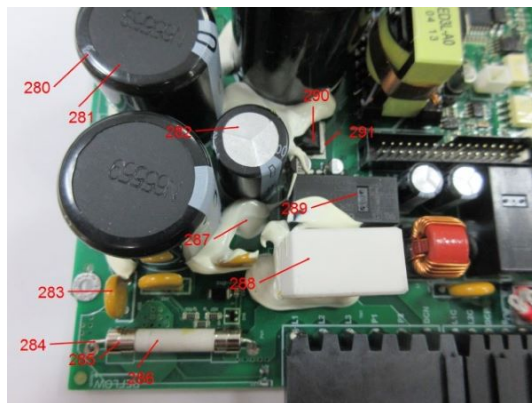
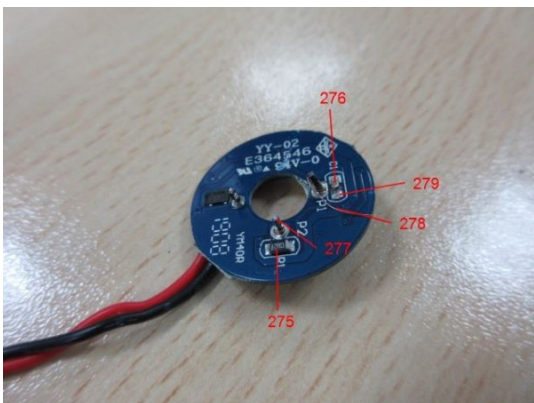
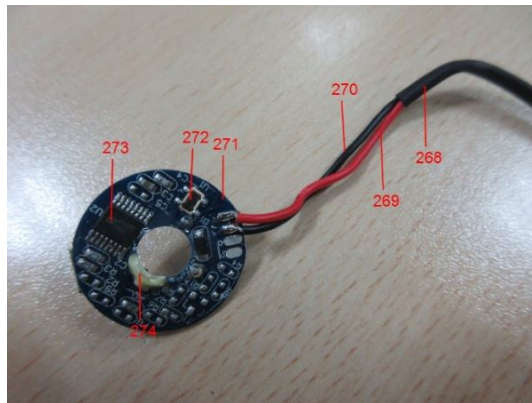

Sample Photos

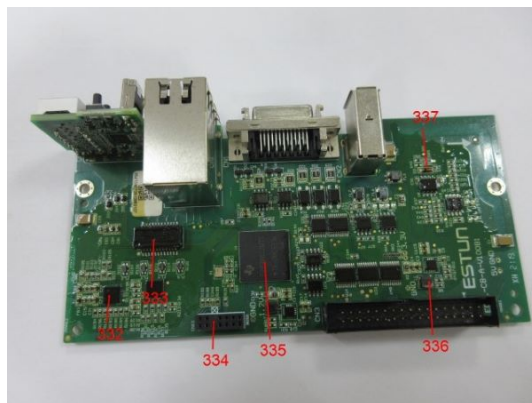
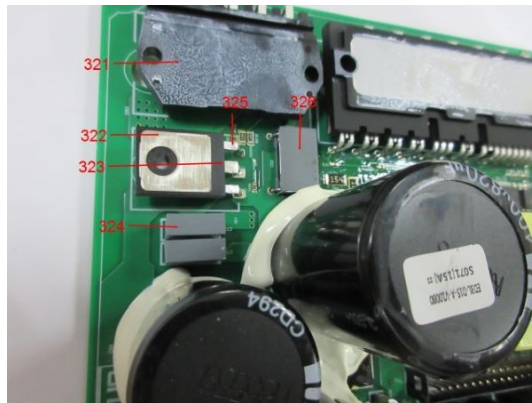
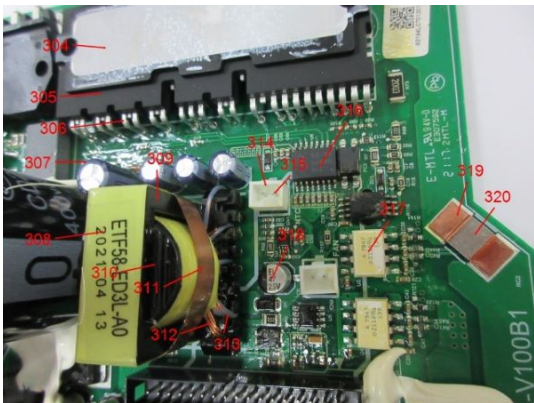
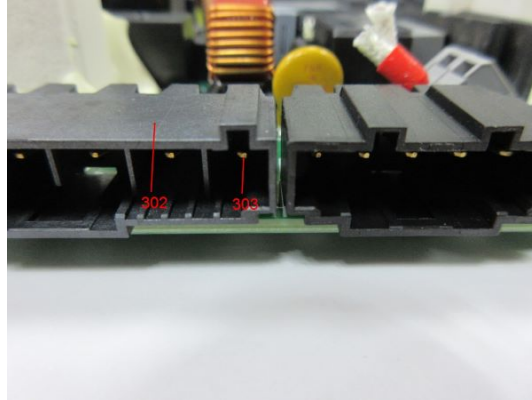

Test Report No.: 244410724a 001 Page 61 of 69

Sample Photos

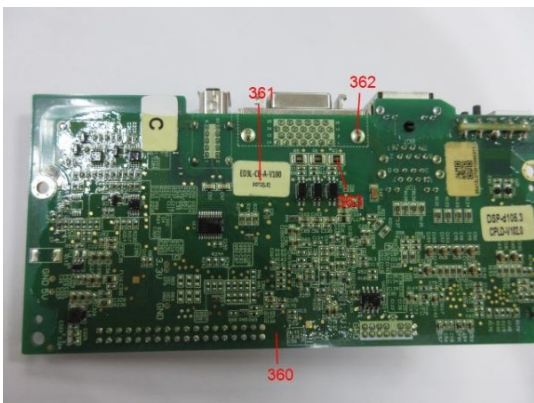
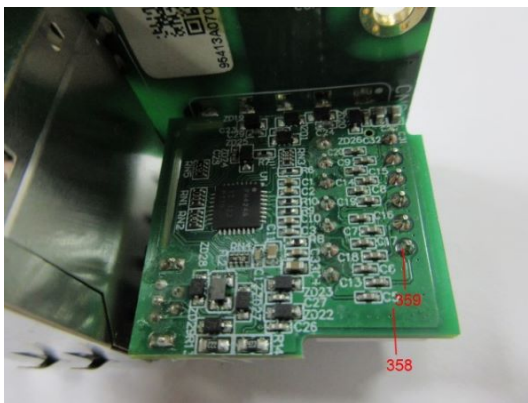
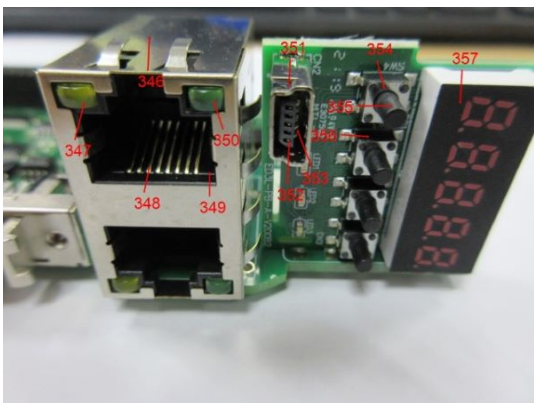
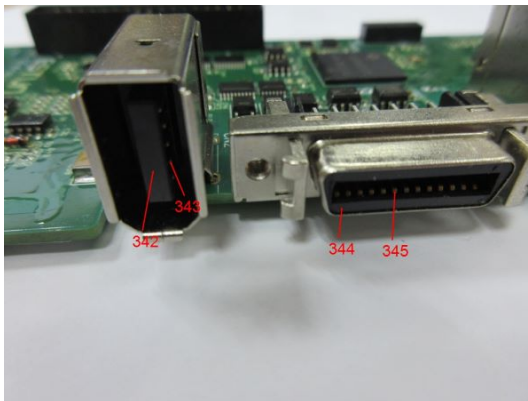
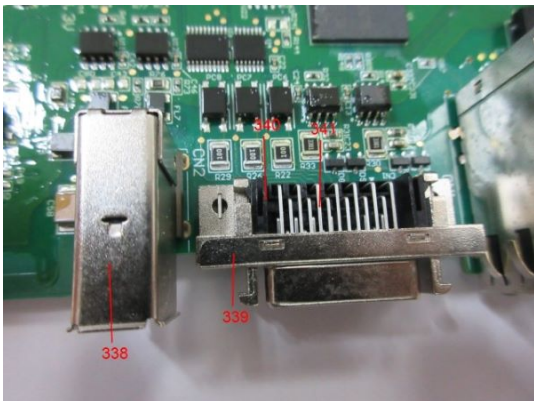

Sample Photos

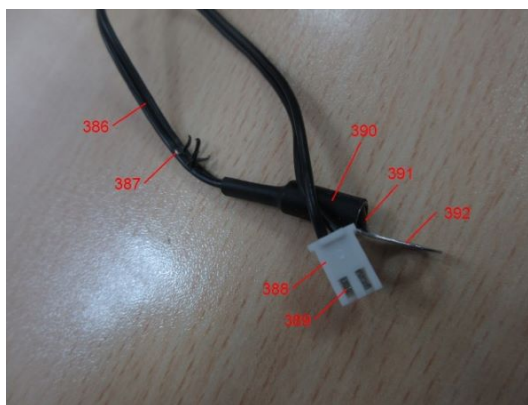
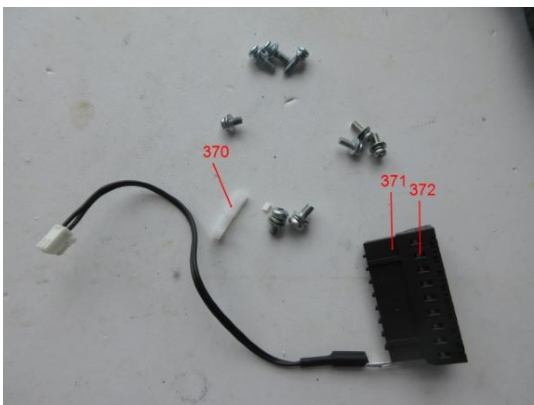
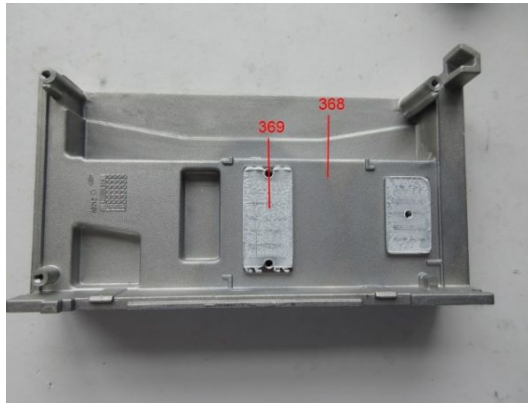

Sample Photos

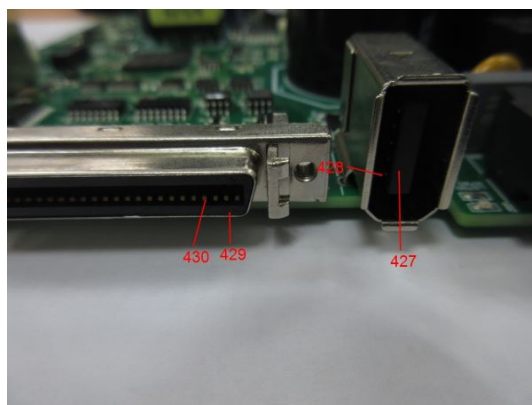
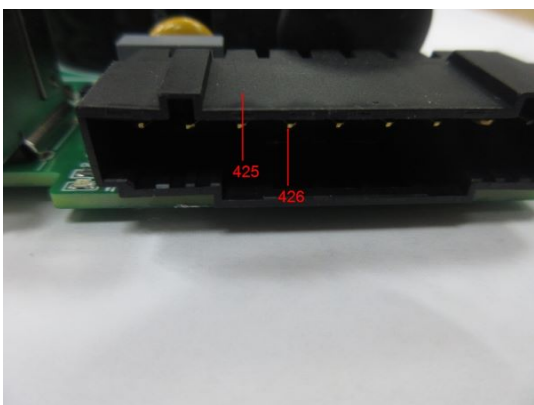
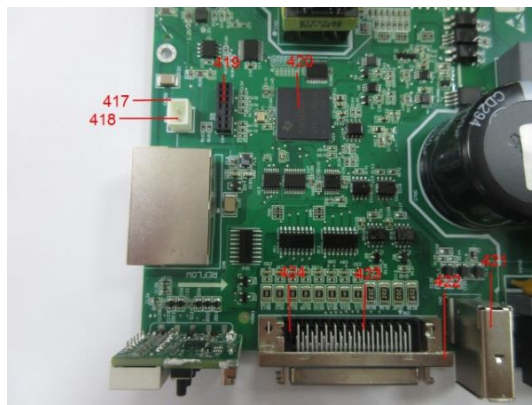
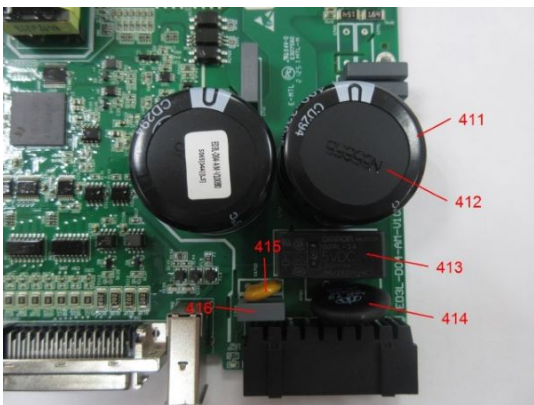
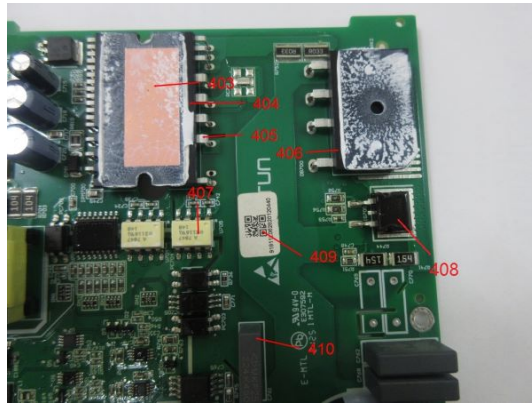
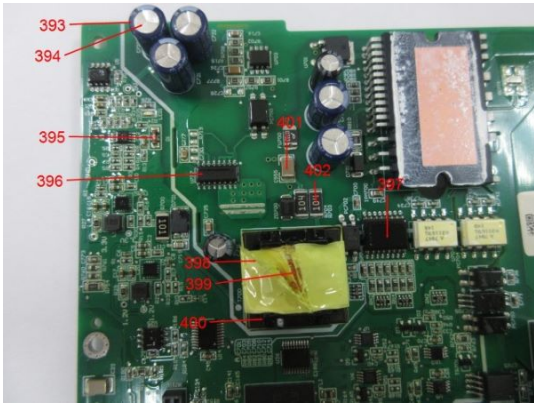

Sample Photos

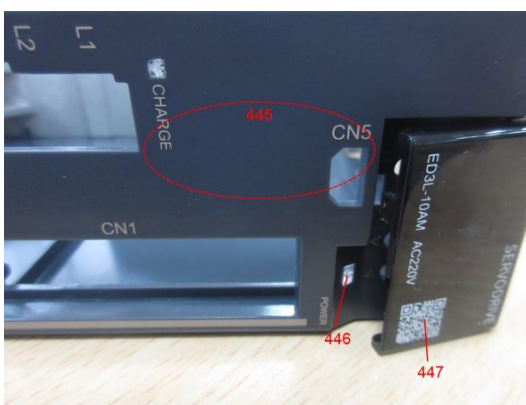
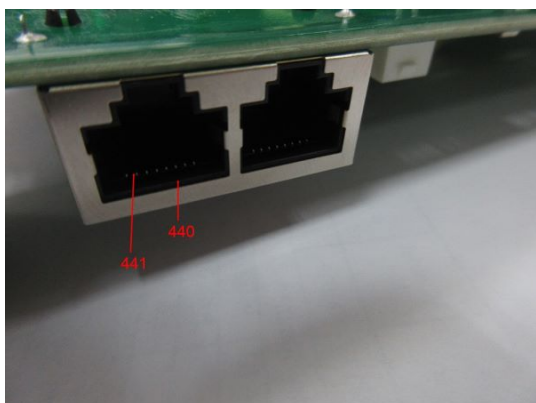
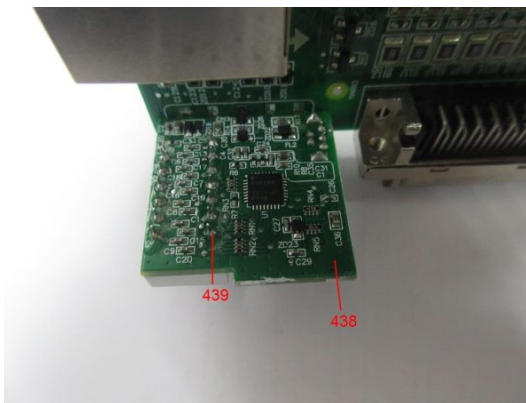
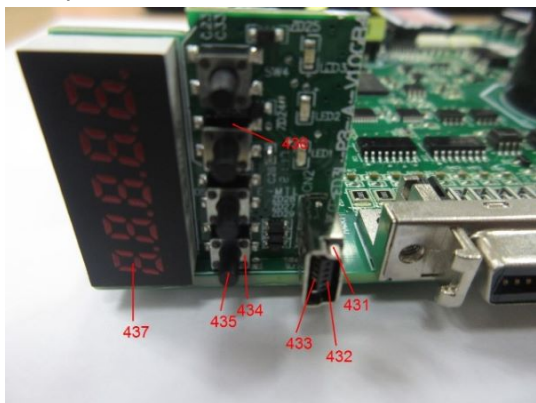

Sample Photos

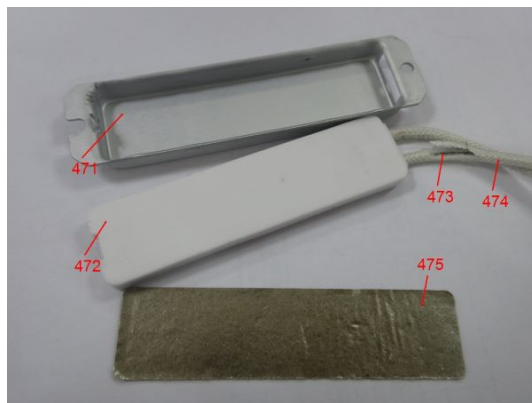
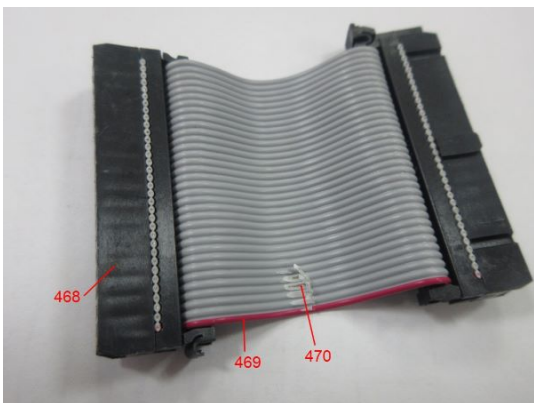
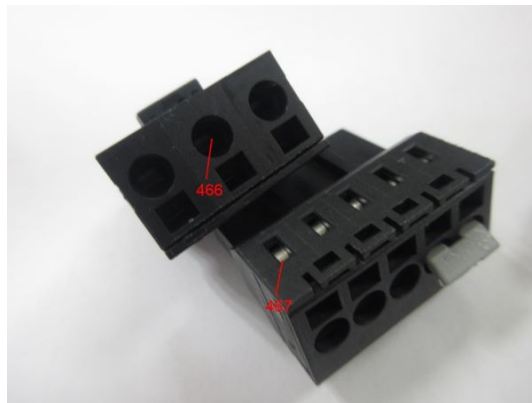
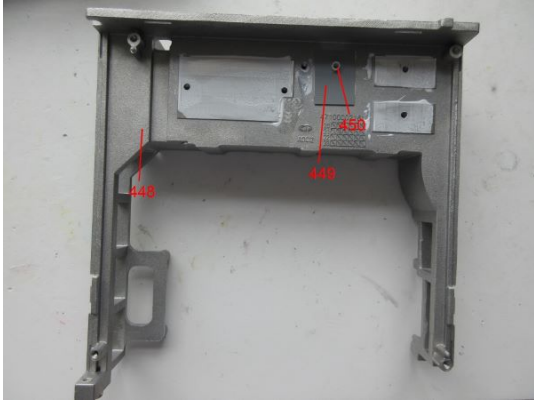

Sample Photos

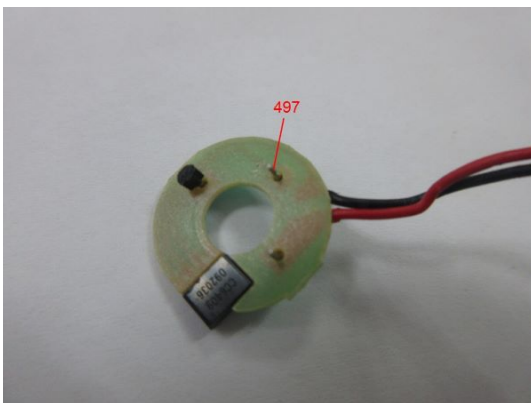
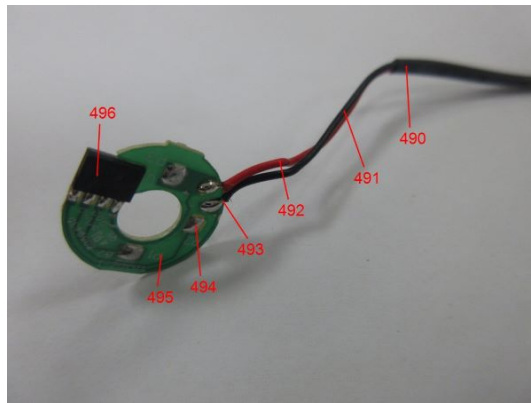
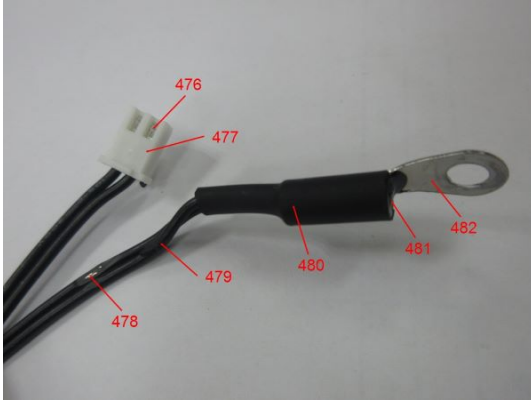

Sample Photos

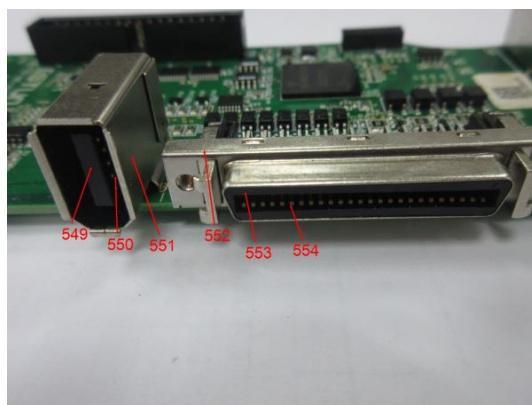
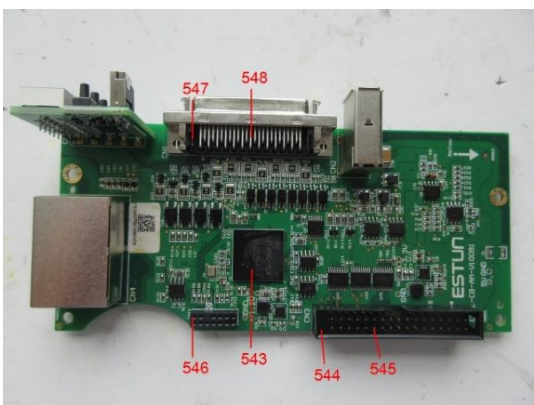
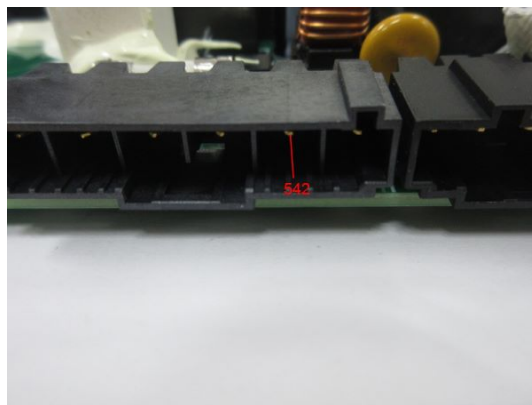
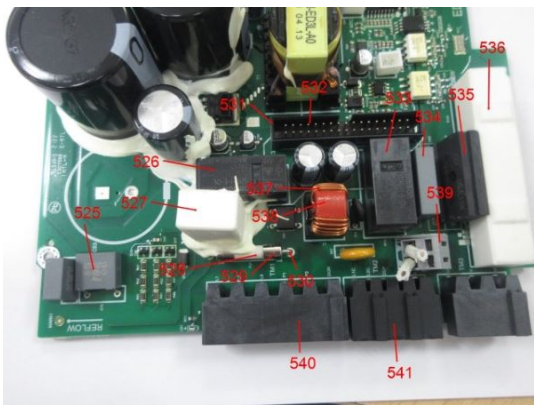
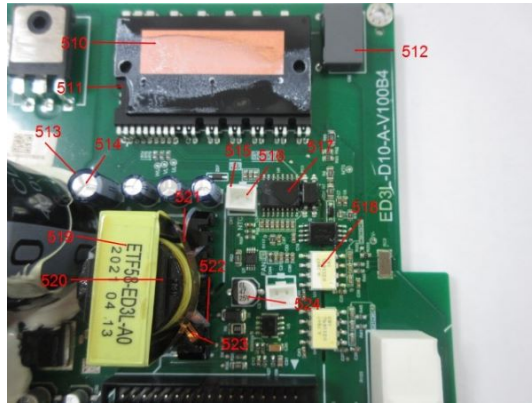
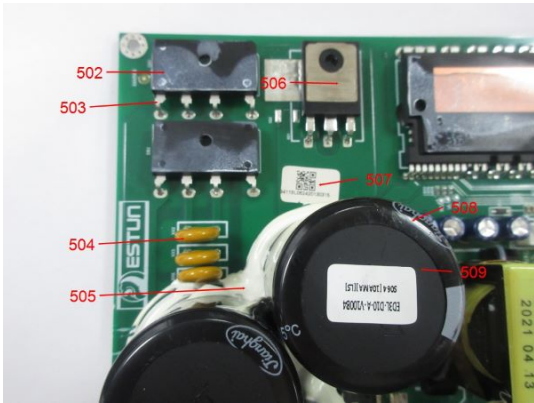

Sample Photos

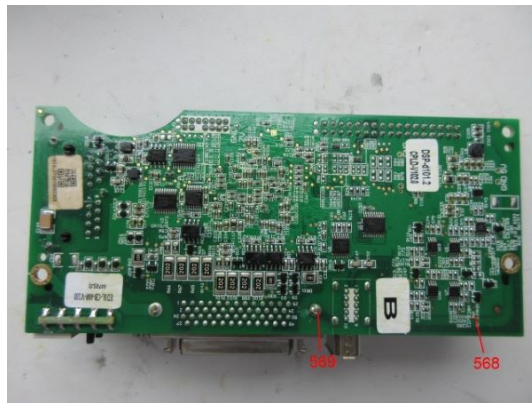
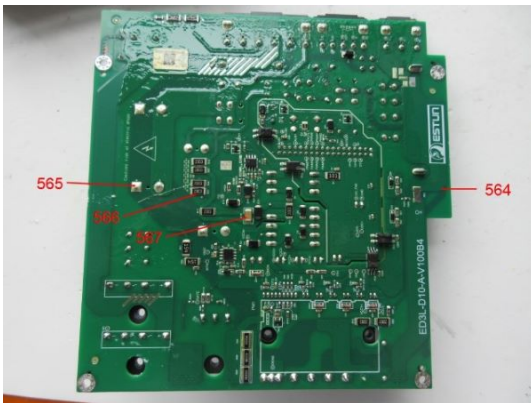

Test Report No.: 244410724a 001

Page 69 of 69

Sample Photos



- END -

